



AIR ASSISTED ATOMIZERS

CTG AZ18 BR



INTRODUCTION

INDEX

Page

INDEX

| | |
|--------------------------------------|----|
| Air assisted atomizing and atomizers | 1 |
| Properties of an atomized spray | 2 |
| Ultrasonic atomizers | 3 |
| Atomizing cart | 5 |
| Classic atomizers | 6 |
| Atomizing set-ups and atomizer code | 7 |
| Atomizing systems layout | 8 |
| Body styles and atomizer options | 9 |
| Pressure atomizers | 12 |
| Siphon atomizers | 15 |
| Large size atomizers | 18 |
| Accessories | 21 |
| Ambient humidification | 23 |

TECHNICAL PUBLICATIONS

PNR manufactures a complete range of spray nozzles for industrial applications as well as several products and systems specifically designed for industrial processes. Information about our Company and products are available in the following publications:

| | |
|--|-------------|
| PNR PRODUCT RANGE | CTG TV10 BR |
| GENERAL PURPOSE SPRAY NOZZLES | CTG UG18 BR |
| AIR ASSISTED ATOMIZERS | CTG AZ18 BR |
| COMPLEMENTARY PRODUCTS AND ASSEMBLY FITTINGS | CTG AC18 BR |
| TANK WASHING SYSTEMS | CTG LS15 BR |
| EVAPORATIVE COOLING SYSTEMS | CTG LN16 BR |
| FIRE FIGHTING COMPONENTS | CTG FF10 BR |
| PAPERMILL PRODUCTS | CTG PM09 BR |
| STEELWORK NOZZLES | CTG SW11 BR |
| SPRAYDRY NOZZLES | CTG SP10 BR |

As a result of continuous product improvement our technical publications are regularly updated and automatically mailed to Customers whose address is registered into our Mailing List. (See page 25). You also find updated Catalogs into our website as shown in the back cover.

NOTE

NOTE

Our products and their specifications are regularly updated to keep up with the latest stage of technology.

We regret not to be able to give previous advice about these changes to our Customers: please consider data and product specifications as given by the Catalog to be purely indicative and not binding for our Company.

Should your application imperatively require that one or more characteristics of a PNR product is strictly adhered to, we ask you to obtain a written confirmation before sending your Order.

All information in this Catalog, like performance data and product codes, diagrams and photographs, are the exclusive property of Flowtech Srl.

Reproducing any part of this Catalog without the written consent of Flowtech is forbidden.

Dimensions in this Catalog are given in millimeters (mm).

All threads are manufactured according to the ISO 228 standard, except where expressly stated.

(European standards BS 2779 – DIN 259 – UNI 338)

Explanations about the abbreviations used in the Catalog are given at page 25.

Product warranty conditions are given at page 25.

All Trademarks used in the Catalog belong to the respective owners.

Our Company has qualified its Quality Management System according to the ISO 9001/2000 Norms.

DNV
Cert. 04111-99-AQ
MIL SINCERT

INTRODUCTION

AIR ASSISTED ATOMIZING

Several industrial processes need the atomizing of liquids into fine and very fine droplets.

This result might be achieved by means of a purely hydraulic nozzle, with the liquid being fed at high pressure through a very small orifice, but the process would originate two main problems:

- A Requiring costly investments and complicated lay-out.
- B Originating plugging problems because of the small orifice dimensions.

In the majority of industrial processes a fine liquid atomization is obtained by means of air assisted atomizers, where compressed air supplies the required energy to break the liquid and to throw the droplets at a given distance from the atomizer.

An air atomizing system has however two inherent limitations:

- A The narrow inside passages require adequate filtering of air and liquid.
- B The high speed jet will only produce narrow angle sprays. To overcome this inconvenience multiple orifice atomizers are used to produce a diverging sprays with better droplet distribution.

AIR ASSISTED ATOMIZERS

The first two sections of the Catalog show two types of atomizers largely used in the industry, the third one deals with complete atomizing systems.

ULTRASONIC ATOMIZERS

These devices provide liquid atomization in two steps:

- A The liquid is injected into the nozzle center and is first atomized by shear action and then mixed with the high speed air stream leaving the nozzle through the outlet orifice.
- B The stream carrying the droplets is taken to impact onto a resonator placed in front of the nozzle orifice, and generates a field of sound waves for additional droplet breakup.

Ultrasonic atomizers produce very fine droplets, in a tight dimensional range, and supply low capacities below 100 liters per hour. Their operation produces a typical noise, the level of which needs to be checked according to the local regulations if some personnel is supposed to work in a nearby area.

CLASSIC ATOMIZERS

These devices produce liquid atomization by simple shear action, providing a high velocity stream to impact onto a liquid flow. In spite of their inherent low efficiency, and because of the low capacities involved, classic atomizers are the most convenient solution for most of the current applications.

A wide range of spray patterns, capacities, atomizer types, body options and accessories has been developed to suit many different requirements from the industry.

HUMIDIFICATION SYSTEMS

The third section of the Catalog shows a range of components expressly designed to be assembled into an highly efficient air humidification system, including air atomizers and their assembly fittings, regulation panels and programming cabinets.

PNR MATERIAL CODES

Many products in this Catalog are available in different materials, and therefore the product codes carry often two letters (XX) which need to be replaced from the required material code.

A list with the most used codes is given in the following, while the complete PNR Material Code List can be requested under the Publication Code 3BZ A01.

| | | | | | |
|-----|----------------------------|----|--------------------------------|-----|------------------------------|
| A1 | Mild steel | D3 | Polyamide (PA) | L1 | Monel 400 |
| A2 | High speed steel | D5 | Polypropylene, w/talcum | L2 | Incolloy 825 |
| A8 | Zinc plated steel | D6 | Polypropylene, 25% glass fiber | L8 | Hastelloy |
| A9 | Nickel plated steel | D7 | High Density Polyethylene | P6 | Acrylic but. styrene (ABS) |
| B1 | AISI 303 Stainless steel | D8 | Polyvinyliden fluoride (PVDF) | P8 | EPDM, 40 Shore |
| B2 | AISI 304 Stainless steel | E0 | EPDM | T1 | Brass |
| B21 | AISI 304 L Stainless steel | E1 | Ethylenpolytetrafluor. (PTFE) | T2 | Chrome plated brass |
| B3 | AISI 316 Stainless steel | E2 | PTFE, 25% glass fiber | T3 | Copper |
| B31 | AISI 316 L Stainless steel | E3 | Acetalic resin (POM) | T8 | Nickel plated brass |
| B8 | AISI 309 Stainless steel | E7 | Viton | T81 | ENP Brass |
| C2 | Aisi 416, Hardened SS | E8 | Synthetic rubber (NBR) | T9 | Brass body, stainless set-up |
| D1 | Polyvinylchloride (PVC) | G1 | Cast iron | V1 | Aluminum |
| D2 | Polypropylene (PP) | H1 | Titanium | V7 | ENP Aluminum |

INTRODUCTION

PROPERTIES OF A LIQUID SPRAY

The atomization of a liquid by means of a compressible fluid, like air, steam or a gas, is defined two-phase or twin-fluid or pneumatic atomization.

Many industrial processes require using finely atomized droplets and the techniques to produce finely atomized sprays have been largely improved in recent years with new types of atomizers being developed.

In addition more sophisticated process techniques have increased the demand for a precise definition about the characteristics of a given spray for the purpose of getting precisely repeatable results. The most interesting parameters defining a given spray have been defined as in the following, and are now available to the process design engineer.

| | |
|---------------------------------------|---|
| Arithmetic Mean Diameter AMD (D10) | This is the arithmetic Mean Value as calculated on the diameters from the total number of the drops in the sample spray. |
| Volume Mean Diameter VMD (D30) | This is the diameter of that drop whose volume is the arithmetic mean from the total number of the drops in the sample spray. |
| Sauter Mean Diameter SMD (D32) | This is the diameter of that drop whose Volume/Surface ratio is the arithmetic mean from the total number of the drops in the sample spray. |

The following Histograms and Diagrams are often used to resume the data referring to the above parameters and give a visual definition of a spray:

- Volume percentage cumulative diagram
- Droplet diameter distribution Histogram
- Droplet velocity distribution Histogram

The dimensional parameters and the above information make it possible to base process calculations on precise data atomization degree, efficiency of heat exchange and spray behavior in a given operation ambient.

The knowledge of a value for the Sauter Mean Diameter SMD (D32) in a given spray is of special importance for the calculation of heating exchange in evaporative cooling processes, since it makes it possible to know the value of the total heat exchange surface obtained atomizing a known quantity of liquid.

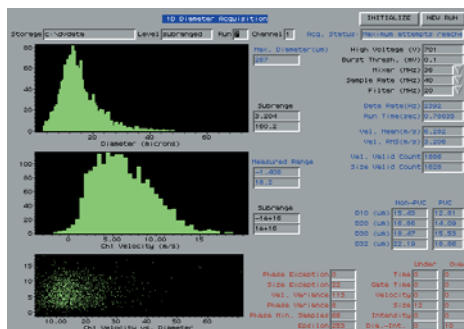

PNR can supply upon request complete documentation containing test reports about the aforementioned parameters for all PNR catalog and special atomizers.

The Histograms beside show the distribution of droplet diameters (D32) and of droplet velocities for one spray obtained in our laboratory.



The photo beside shows a test performed in our laboratory.

A Laser Interferometer is used to measure and record the spray parameters, while fluid flow rates and feed pressures are monitored with high precision instruments.

NOTE

Please note that all capacity values given in this catalog refer to test performed using water and compressed air. Atomizing liquids other than water, or using motive fluids different from compressed air will modify the performance of any atomizer, which have to be assessed through a laboratory test.

ULTRASONIC ATOMIZERS

Ultrasonic atomizers operate on a very sophisticated process which is based on two steps:

In the first one tiny water jets are injected into an high speed air flow which provides a first break up and atomization of the fluid.

In the second step the two phase flow, air entraining liquid droplets, goes trough a field of sound waves which produce a further break up and a lower droplet dimension.

This is realized through an impact between the two phase flow and a resonator located in front of the nozzle orifice.

Ultrasonic atomizers can only be manufactured with high precision machining operations but offer the following remarkable advantages.



A The droplets in the atomized jet show low values for the Sauter Mean Diameter, and in addition a rather narrow range of individual droplet diameter: in other words the drops are very small and with little difference in diameter between the smallest and the biggest droplet. This means the spray is made by droplets very small and very similar in size, which is very important in all evaporative processes like for example air humidification: it is rather easy then to obtain values for the evaporation time and evaporation length of a given spray.

B The noticeable variations in local air pressure all around the resonator, associated to the sound waves, eliminate the danger of dust and foreign particles build-up in the vicinity of the nozzle orifice, thus avoiding a decay in the atomizer performance.

The system will then be very reliable and require limited or null maintenance.

Ultrasonic atomizers



Atomizing carts



ULTRASONIC ATOMIZERS

ATOMIZERS AND FITTINGS

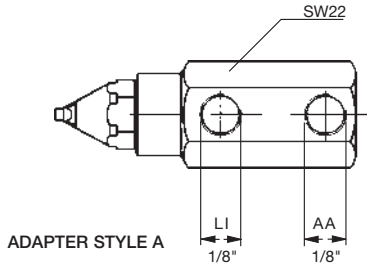

ADAPTER STYLE A

Ultrasonic atomizers produce the finest sprays available with air assistance for industrial processes, with a narrow angle full cone jet.

Water and air do not mix in a confined volume before leaving the nozzle and therefore their feed pressures can be adjusted independently without influencing each other: this allows for a very wide regulation range on the liquid capacity and makes it easier to reach the desired operating conditions.

Please note that the code given in the table only refers to the atomizing head and must be completed with the identification for one of the four connection adapters available, as shown below in the page.

The drawing beside shows an atomizing head assembled onto one A type adapter.

- Materials Atomizing head B1 AISI 303 stainless steel
- Adapter B1 AISI 303 stainless steel
- T1 Brass

WM = Water capacity (l/min)

AH = Air capacity (Ncm/h)

IDENTIFICATION CODES

ATOMIZING HEAD

The codes given in the table refer to the atomizing head only, and can be used to order the head as a separate part.

ADAPTERS

Can be ordered separately using the codes below, please replace

XX = B1 for AISI 303

XX = T1 for brass

COMPLETE ATOMIZERS

To identify a complete atomizer, please add to the head code the two suffix letters describing the adapter material and the adapter style according to the information below.

MAD 0801 B1 Y Z

Adapter Material

A = T1 Brass

B = B1 AISI 303

Adapter style

A = XMA 0103 xx

B = XMA 0101 xx

C = XMA 0102 xx

D = XMA 0100 xx

| Set-up Code | | Air pressure (bar) | | | | | | | | | | |
|-------------|-------------|--------------------|------|------|------|------|------|------|------|------|------|------|
| | | 0,5 | | 0,7 | | 1,0 | | 2,0 | | 3,0 | | |
| | | WM | AH | WM | AH | WM | AH | WM | AH | WM | AH | |
| 25° | MAD 0331 B1 | 2 | 0,10 | 3,1 | 0,12 | 3,0 | 0,15 | 3,1 | 0,27 | 2,7 | - | - |
| | | 3 | 0,05 | 3,7 | 0,10 | 3,1 | 0,12 | 3,6 | 0,20 | 3,7 | 0,32 | 2,9 |
| | | 4 | 0,02 | 4,7 | 0,05 | 4,8 | 0,08 | 4,4 | 0,18 | 4,4 | 0,25 | 4,2 |
| | | 5 | - | - | 0,02 | 5,3 | 0,05 | 5,3 | 0,13 | 5,5 | 0,22 | 5,2 |
| | | 6 | - | - | - | - | 0,02 | 6,1 | 0,12 | 6,0 | 0,18 | 5,8 |
| | | 6 | - | - | - | - | - | - | - | - | - | - |
| | MAD 0801 B1 | 2 | 0,23 | 2,7 | 0,28 | 2,9 | 0,37 | 2,7 | 0,72 | 2,2 | - | - |
| | | 3 | 0,22 | 3,6 | 0,27 | 3,6 | 0,32 | 3,5 | 0,52 | 3,2 | 0,82 | 2,7 |
| | | 4 | 0,18 | 4,5 | 0,22 | 4,4 | 0,28 | 4,6 | 0,45 | 4,6 | 0,62 | 4,7 |
| | | 5 | 0,12 | 5,4 | 0,18 | 5,3 | 0,25 | 5,6 | 0,40 | 5,4 | 0,53 | 5,4 |
| | | 6 | 0,07 | 6,2 | 0,13 | 6,3 | 0,22 | 6,2 | 0,35 | 6,3 | 0,50 | 6,2 |
| | | 6 | - | - | - | - | - | - | - | - | - | - |
| | MAD 1131 B1 | 2 | 0,50 | 7,3 | 0,60 | 6,6 | 0,73 | 6,9 | 1,15 | 5,6 | - | - |
| | | 3 | 0,40 | 9,7 | 0,50 | 9,5 | 0,65 | 9,4 | 0,96 | 9,3 | 1,35 | 7,9 |
| | | 4 | 0,27 | 11,6 | 0,37 | 11,9 | 0,55 | 11,8 | 0,93 | 12,1 | 1,20 | 11,5 |
| | | 5 | 0,13 | 13,9 | 0,23 | 13,8 | 0,38 | 14,0 | 0,87 | 14,1 | 1,15 | 13,8 |
| | | 6 | 0,07 | 18,6 | 0,13 | 18,7 | 0,27 | 18,7 | 0,72 | 18,9 | 1,10 | 19,0 |
| | | 6 | - | - | - | - | - | - | - | - | - | - |
| 40° | MAL 0800 B1 | 2 | 0,18 | 2,7 | 0,23 | 2,7 | 0,32 | 2,9 | 0,73 | 2,1 | - | - |
| | | 3 | 0,15 | 3,7 | 0,18 | 3,9 | 0,25 | 3,5 | 0,50 | 3,7 | 0,85 | 2,6 |
| | | 4 | 0,10 | 4,5 | 0,17 | 4,6 | 0,22 | 4,9 | 0,33 | 4,8 | 0,53 | 4,4 |
| | | 5 | 0,03 | 5,4 | 0,10 | 5,6 | 0,18 | 5,4 | 0,30 | 5,4 | 0,45 | 5,3 |
| | | 6 | - | - | 0,03 | 6,2 | 0,12 | 6,3 | 0,27 | 6,2 | 0,38 | 6,3 |
| | | 6 | - | - | - | - | - | - | - | - | - | - |
| | MAL 1130 B1 | 2 | 0,46 | 7,3 | 0,52 | 7,2 | 0,68 | 6,8 | 1,13 | 5,7 | - | - |
| | | 3 | 0,38 | 9,5 | 0,47 | 9,7 | 0,65 | 10,2 | 0,95 | 9,4 | 1,27 | 7,7 |
| | | 4 | 0,23 | 11,8 | 0,35 | 11,8 | 0,50 | 11,9 | 0,88 | 12,1 | 1,15 | 11,8 |
| | | 5 | 0,13 | 13,5 | 0,23 | 13,9 | 0,37 | 14,0 | 0,82 | 14,1 | 1,10 | 14,2 |
| | | 6 | 0,07 | 16,0 | 0,13 | 16,2 | 0,27 | 16,2 | 0,63 | 16,2 | 1,03 | 16,3 |
| | | 6 | - | - | - | - | - | - | - | - | - | - |
| | MAL 1300 B1 | 2 | 0,95 | 14,6 | 1,12 | 16,5 | 1,40 | 16,3 | 2,42 | 10,4 | - | - |
| | | 3 | 0,80 | 19,3 | 1,00 | 20,0 | 1,26 | 22,2 | 1,90 | 19,2 | 2,87 | 14,5 |
| | | 4 | 0,60 | 24,7 | 0,80 | 24,7 | 1,08 | 25,0 | 1,80 | 25,0 | 2,40 | 23,2 |
| | | 5 | 0,42 | 29,9 | 0,60 | 30,3 | 0,90 | 30,4 | 1,70 | 30,5 | 2,27 | 29,9 |
| | | 6 | 0,23 | 35,6 | 0,40 | 36,0 | 0,67 | 35,6 | 1,55 | 36,2 | 2,15 | 35,2 |
| | | 6 | - | - | - | - | - | - | - | - | - | - |

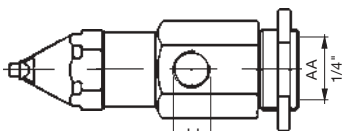

ADAPTER STYLE B

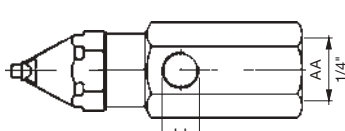

ADAPTER STYLE C

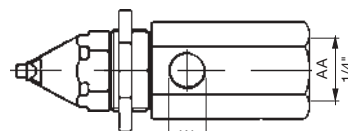

ADAPTER STYLE D

LOCKNUT FITS BOTH FRONT AND REAR THREADED BODIES.

B and D adapter style allow for mounting the atomizer through a wall or the side of a duct. In this case do not forget to order the VAC 0021 B1 locknut, which fits both, to hold the adapter in place.

ULTRASONIC ATOMIZERS

ATOMIZING CARTS

ATOMIZING CARTS

This type of atomizing cart makes it possible to atomize into the air of confined rooms liquids without requiring an operator to be present, the typical example being spraying disinfectants in hospital rooms.

These devices combine the ease of mobility with long operation times and can be efficiently operated by all kind of personnel after a very simple training.

The solution to be atomized is contained into the stainless steel tank, where it is put under pressure by means of the same compressed air used for the atomization process and which must be available on the spot.

Up to three atomizers for a maximum capacity of 7,2 l/min can be assembled onto the cart, each of them mounted on a swivel head for efficient ambient saturation.

Ease of mobility is assured from two rubber lined wheels and a convenient handle.

The device can be operated with simple manual controls, or from a PLC unit which allows for setting an operation time and a start delay for allowing the operator to leave the room before atomizing starts.

| | |
|----------------------------|---------------|
| Weight with manual control | 13 kg (empty) |
| Tank volume | 19 liters |

Atomizing carts are designed on customer requirements, therefore no standard range coding is available.

A certificate according to European PED norms is released for each tank.



CLASSIC ATOMIZERS



Classic atomizers are devices producing an atomized spray with the assistance of compressed air, where the liquid is broken into droplets when its outer surface is subjected to shear action from the high speed air flow. By assembling together a range of standard components in different materials, several different capacity values, spray patterns, spray angles and operation modes can be obtained. In addition, specific application problems can be addressed by the use of special accessories available on request.



Page 7

ATOMIZER SET-UP

The set-up is the device where air and liquid flow come in contact and produce the atomized jet.

It consists of a liquid nozzle and an air nozzle, whose orifice dimensions are combined in several different ways in order to obtain the capacity, the spray pattern and the spray angle required.

The above spray parameters are given in the performance tables, besides each set-up code.



Page 8

ATOMIZER BODIES

The atomizer body serves the purpose of conveniently connecting the set-up to the feed lines for air and water, and it may include some options like shut-off or orifice cleaning needles.

In addition to the MW type, the standard body, a more complete MX type includes an air operated cylinder for remote control of spray operation.



Page 21

ACCESSORIES AND OPTIONS

In addition to the standard range of components some specific requirements like resistance to internal erosion or solid build-up from water borne foreign matters, body options with a different design or different spray control procedures, can be addressed with special parts.



Page 23

COMPLETE SYSTEM

An atomizing system is often used to control the humidity value in a confined room, like a wine cellar, or to spray some special products in the ambient atmosphere for different purposes.

In addition to our range of high quality atomizers we can supply regulation cabinets and spray control panels which allow to assemble of a professional and highly efficient atomizing system.

CLASSIC ATOMIZERS

SPRAY SET-UP

A spray set-up is made out of a liquid nozzle and an air nozzle. When assembled the air nozzle fits precisely onto the liquid nozzle and the combination of the two provides the correct inside geometry to produce the spray.

Such parameters of the two parts like the number, dimensions and profile of their inside passages determines all the characteristics of the atomized spray produced by that given set-up.

A set-up can be selected according to the choices beside.

The capacity tables in the following catalog pages show the specification of each individual set-up, that is air and liquid capacities as a function of air and liquid feed pressures, and spray dimensions.

Spray dimensions are understood measured in still air for several pressure values, and cannot be precisely defined, therefore we give indicative values of the maximum throw and of the distance for which the spray maintains a consistent shape.

SPRAY PATTERN

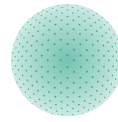

FULL CONE
Round spray pattern

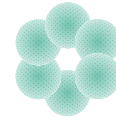

WIDE FULL CONE
Cluster spray pattern



FLAT JET SPRAY
Flat spray pattern

| | | |
|----------------------------|------------------|--------|
| OPERATION PRINCIPLE | Internal mix | Page 8 |
| | External mix | |
| LIQUID FEED | Pressure feeding | Page 8 |
| | Siphon feeding | |

SET-UP PARTS

The set-up code, complete with the material code, can be used to order air and liquid nozzle together.

Under the set-up code, air (An) and liquid nozzle (Ln) codes are shown separately for ordering them as spare parts, while Teflon seal and locknut can be ordered with the codes shown beside.

All Pnr components are made interchangeable and can be combined even if made in different materials, like for example assembling an erosion resistant set-up in stainless steel with a brass body.



LOCKNUT



AIR NOZZLE

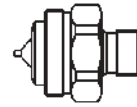

LIQUID NOZZLE



SEAL

XMW 0010 XX

VDA 0020 E1*

| | |
|----------------------|--------------------|
| Set-up code | SUB 1520 |
| Ln XMW 5001xx | Liquid nozzle code |
| An XMW 4001xx | Air nozzle code |

* Standard seal is Teflon, copper gasket VDA 0020 T3

COMPLETE ATOMIZER CODE

Once the set-up code (and therefore the spray characteristics, has been chosen) it is necessary to choose the body and the options required to come to the complete atomizer code.

A set-up can be assembled basically on two different body types:

BASIC BODY

This body serves the only purpose of connecting the set-up inlets to the air and liquid feed lines. The plug on the body top can be replaced by several option equipment as shown next page

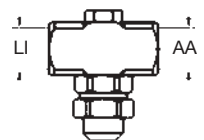

AIR ACTUATED BODY

This body has a built in air cylinder allowing to start and stop the spray from a remote location. Additional options are shown at page 10 and 21.

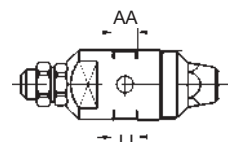

ATOMIZZATORI CONVENZIONALI

ATOMIZER FEEDING

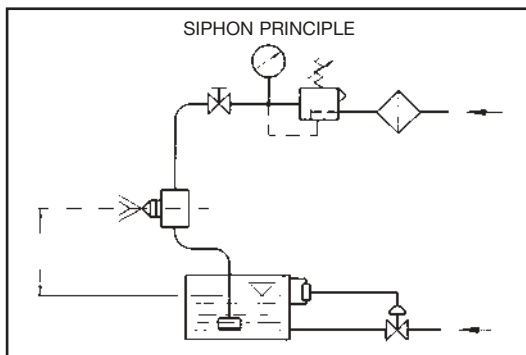
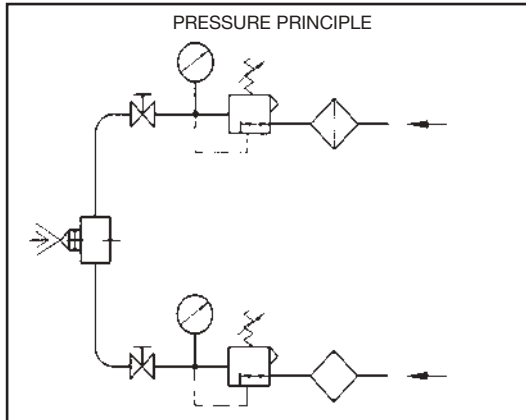

An atomizer can work on two different liquid feed principles, that is

- Liquid is supplied to the atomizer through a line under pressure.
- Liquid is aspirated by the atomizer from a container at ambient pressure.

PRESSURE PRINCIPLE

It is the most widely used, and therefore a large range of capacities and spray patterns are available.

Liquid capacity, air capacity and droplet sizes can be adjusted by regulating the air and liquid feed pressures and the two fluids are mixed inside the atomizer prior to be ejected.

(Internal mix atomizers).

A different type allows for mixing the fluids just after they are ejected from the orifice, avoiding mutual influence of the two fluid pressure values inside a mixing chamber and allowing wider regulation range.

(External mix atomizers).

SIPHON PRINCIPLE

These atomizers offer lower capacity values for liquids and a simpler layout since the liquid is aspirated from the atomizer through a Venturi effect.

The liquid is simply supplied from an open container, whose level can be lower or higher than the atomizer one to fine tune the liquid capacity.

The atomizing air provides the vacuum necessary into the mixing chamber for the Venturi effect.

JET FORMATION

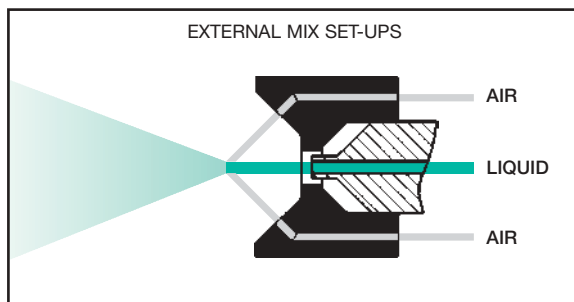
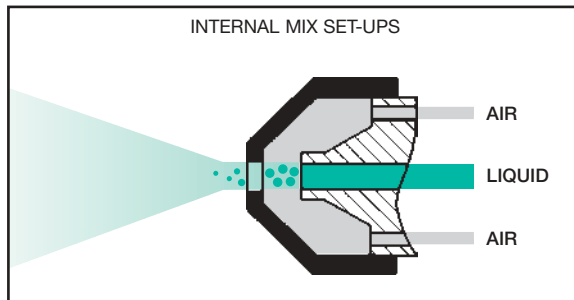

The set-up can be designed in two different ways so as to obtain the following actions

- Air and liquid are mixed up in a mixing chamber inside the atomizer and then they are ejected through the orifice as a spray.
- Air and liquid are ejected from the atomizer through different orifices, and the spray is generated by the impact of the two jets.

INTERNAL MIX SET-UPS

The spray is ejected from one or more orifices in the wall of a mixing chamber.

In these atomizers a change in the pressure of one of the fluids inside the mixing chamber has an influence on the capacity of the second fluid and this effect reduces the ease of regulation.

As an example, increasing the air pressure will decrease the liquid quantity being atomized and the droplet size, and vice-versa.

EXTERNAL MIX SET-UPS

The two fluids are ejected through different orifices, their mixing happens outside the orifice.

Therefore their pressure values can be adjusted avoiding cross influence with a more precise and stable regulation.

External mix set-ups can only work with liquid feed under pressure, and only produce flat jet sprays.

CLASSIC ATOMIZERS

BODY TYPES AND OPTIONS

MW

COMPLETE CODE

To obtain the complete code for an atomizer it is necessary to use the set-up code you have chosen from the performance table and complete it with the code for body and options as follows:





- Replace the first two letters in the set-up code (the SU) with the code for standard body (MW).
- Add the code for the material you require.
- Add the code for the required options, if any.

MWB 1520 **B1** **B**

MATERIALS

- B1 = AISI 303 Stainless steel
 B3 = AISI 316 Stainless steel
 D1 = PVC
 E6 = Lucite
 T8 = Nickel plated brass

OPTIONS

- A  BASIC BODY
- B  SHUT-OFF NEEDLE
- C  CLEANING NEEDLE
- D  CLEAN AND SHUT-OFF NEEDLE

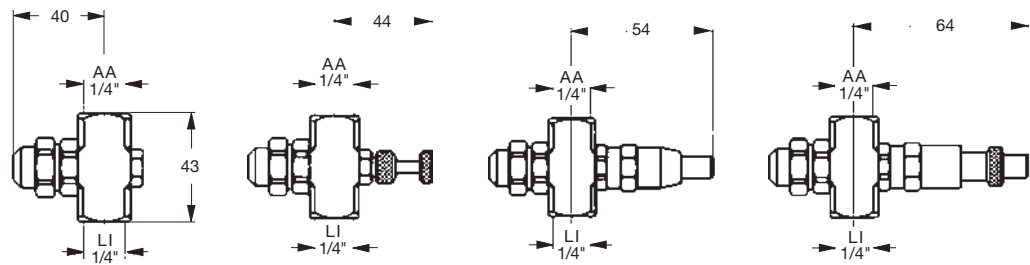

AA = Air inlet 1/4" female
 LI = Liquid inlet 1/4" female

CLASSIC ATOMIZERS

MX

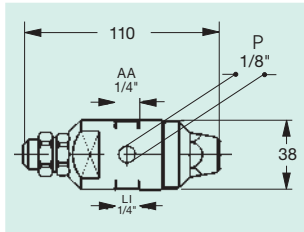

STANDARD SIZE

AA = 1/4" atomizing air inlet

LI = 1/4" liquid inlet

AC = 1/8" cylinder air inlet

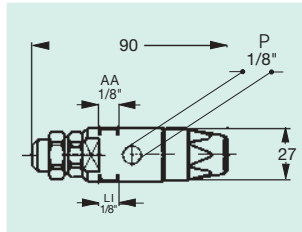

CORPO MINI

AA = 1/8" atomizing air inlet

LI = 1/8" liquid inlet

AC = 1/8" cylinder air inlet

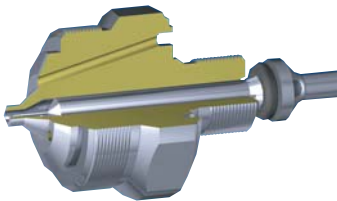

COMPLETE CODE

To obtain the complete code for an atomizer it is necessary to use the set-up code you have chosen from the performance table and complete it with the code for body and options as follows.

- Replace the first two letters in the set-up code (the SU) with the code for air actuated body (MX).
- Add the code for the material you require.
- Add the code for the required options, if any.

MXB 1520 B1 B

MATERIALS

B1 = AISI 303 Stainless steel

B3 = AISI 316 Stainless steel

T8 = Nickel plated brass

OPTIONS

A SHUT-OFF NEEDLE

B CLEANING NEEDLE

MA SHUT-OFF NEEDLE, MINI

MB CLEANING NEEDLE, MINI

U SINGLE AIR INLET

BODY TYPES AND OPTIONS

AIR ACTUATED ATOMIZER

MX bodies contain an air actuated cylinder which controls the spray operation by means of a needle, opening or closing the water inlet in the liquid nozzle.

Normally the air used for atomizing the liquid flows continuously, while the air to the actuator is used to start and stop the atomizing cycles.

For longer idle times between two atomizing cycles, where too much atomizing air would be wasted, sequenced shut-off should be organized for the two air lines.

The air actuator air should be stopped (and the liquid flow interrupted) before atomizing air to be sure all liquid inside is completely atomized and dripping is avoided.

Conversely, when spray begins, atomizing air should be started first so that incoming liquid is atomized without dripping.

Single air option is explained at page 21.

NO-DRIP NEEDLE

Our engineers have invented, developed and introduced on the market a no-drip needle (Italian Patent MI96U-00541) to assure positive liquid shut-off and completely drip-free operation.

This solved completely the old problem of dripping atomizers as offered from our competitors.

All air actuated PNR atomizers include this better and more consistent design as standard.

INTERNAL MIX SET-UPS

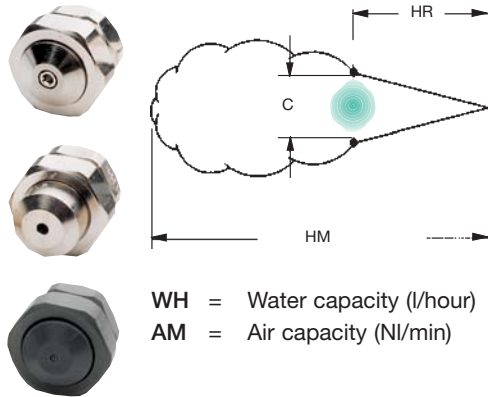

FULL CONE SPRAY

These single orifice set-ups produce narrow angle, full cone shaped, atomized sprays with a spray angle of about 20°.

More precise details on the spray dimensions are given in the table on the right side of the page.

The spray length can reach from 2.500 to 9.000 mm depending upon the set-up type and operating conditions.

See advice on adjustment for flow rates and droplet size given at page 8.

WH = Water capacity (l/hour)
AM = Air capacity (NI/min)

Materials B1 AISI 303 Stainless steel
B3 AISI 316 Stainless steel
D1 PVC
T8 Nickel plated brass

| Set-up Code | Air pressure (bar) | | | | | | | | | | | | | | | | | |
|-------------|--------------------|------|------|-----|------|------|-----|------|------|-----|------|------|-----|-----|------|-----|------|---|
| | WH | | AM | | WH | | AM | | WH | | AM | | WH | AM | PA | PL | HR | C |
| SUB 1520 | 0,7 | 2,5 | 15,6 | 1,4 | 6,4 | 13,9 | 2,7 | 6,2 | 23,0 | 3,5 | 7,8 | 28,0 | - | - | - | - | - | - |
| | 0,9 | 1,8 | 19,0 | 1,7 | 5,5 | 16,7 | 2,8 | 5,7 | 25,0 | 3,7 | 7,3 | 29,0 | 0,9 | 0,7 | 300 | 68 | 2700 | |
| | 1,0 | 1,4 | 22,0 | 2,0 | 4,5 | 19,8 | 3,0 | 5,2 | 27,0 | 3,9 | 6,4 | 33,0 | 1,7 | 1,5 | 330 | 75 | 3000 | |
| | - | - | - | 2,2 | 3,4 | 24,0 | 3,1 | 4,7 | 29,0 | 4,2 | 5,5 | 38,0 | 2,5 | 2,0 | 360 | 82 | 3400 | |
| | - | - | - | 2,4 | 3,0 | 26,0 | 3,2 | 4,3 | 31,0 | 4,5 | 4,5 | 43,0 | 3,1 | 3,0 | 390 | 96 | 3800 | |
| Ln XMW 5001 | - | - | - | 2,5 | 2,5 | 28,0 | 3,4 | 3,9 | 33,0 | 4,6 | 4,1 | 45,0 | 4,5 | 4,0 | 440 | 116 | 4400 | |
| An XMW 4001 | - | - | - | 2,7 | 2,3 | 31,0 | 3,7 | 3,0 | 38,0 | 4,8 | 3,7 | 47,0 | - | - | - | - | - | |
| SUB 1670 | 0,7 | 2,5 | 18,7 | 1,7 | 6,7 | 29,0 | 2,2 | 9,2 | 34,0 | 2,8 | 11,9 | 39,0 | - | - | - | - | - | - |
| | 0,9 | 2,0 | 22,0 | 1,8 | 6,4 | 31,0 | 2,5 | 8,2 | 39,0 | 3,1 | 11,0 | 43,0 | 0,9 | 0,7 | 430 | 90 | 3700 | |
| | 1,0 | 1,6 | 26,0 | 2,0 | 5,9 | 34,0 | 2,8 | 7,2 | 44,0 | 3,4 | 10,1 | 47,0 | 1,5 | 1,5 | 460 | 105 | 4000 | |
| | - | - | - | 2,1 | 5,2 | 37,0 | 3,0 | 6,7 | 47,0 | 3,7 | 9,2 | 52,0 | 2,4 | 2,0 | 480 | 109 | 4300 | |
| | - | - | - | 2,2 | 4,8 | 40,0 | 3,1 | 6,3 | 49,0 | 3,9 | 8,4 | 58,0 | 3,0 | 3,0 | 510 | 116 | 4600 | |
| Ln XMW 5001 | - | - | - | 2,4 | 4,3 | 43,0 | 3,2 | 5,9 | 52,0 | 4,2 | 7,6 | 62,0 | 3,9 | 4,0 | 560 | 147 | 5200 | |
| An XMW 4002 | - | - | - | 2,7 | 3,6 | 48,0 | 3,4 | 5,5 | 55,0 | 4,5 | 6,8 | 68,0 | - | - | - | - | - | |
| SUB 2142 | 0,9 | 4,8 | 21,0 | 2,0 | 10,7 | 33,0 | 2,7 | 16,5 | 37,0 | 3,4 | 20,0 | 43,0 | - | - | - | - | - | - |
| | 1,1 | 4,1 | 27,0 | 2,1 | 9,8 | 37,0 | 2,8 | 15,4 | 38,0 | 3,7 | 18,4 | 47,0 | 1,5 | 0,7 | 480 | 100 | 4000 | |
| | 1,4 | 3,4 | 33,0 | 2,4 | 8,2 | 42,0 | 3,1 | 13,6 | 43,0 | 3,9 | 16,8 | 50,0 | 2,5 | 1,5 | 510 | 116 | 4300 | |
| | 1,5 | 3,1 | 35,0 | 2,7 | 6,8 | 48,0 | 3,4 | 11,8 | 49,0 | 4,2 | 15,2 | 55,0 | 3,0 | 2,0 | 530 | 120 | 4600 | |
| | 1,7 | 3,0 | 39,0 | 3,0 | 5,9 | 55,0 | 3,7 | 10,4 | 55,0 | 4,5 | 13,8 | 60,0 | 3,4 | 3,0 | 560 | 137 | 4900 | |
| Ln XMW 5002 | 1,8 | 2,9 | 41,0 | 3,2 | 5,0 | 59,0 | 3,9 | 9,1 | 61,0 | 4,8 | 12,4 | 65,0 | 4,2 | 4,0 | 600 | 158 | 5300 | |
| An XMW 4002 | 2,0 | 2,8 | 44,0 | 3,5 | 4,1 | 65,0 | 4,2 | 7,9 | 65,0 | 4,9 | 11,8 | 68,0 | - | - | - | - | - | |
| SUC 2376 | 1,1 | 13,0 | 76,0 | 2,8 | 20,0 | 136 | 3,4 | 32,0 | 149 | 4,6 | 37,0 | 193 | - | - | - | - | - | - |
| | 1,4 | 8,9 | 91,0 | 3,1 | 16,3 | 149 | 3,9 | 25,0 | 170 | 5,3 | 29,0 | 220 | 1,7 | 0,7 | 660 | 209 | 4900 | |
| | 1,5 | 7,2 | 98,0 | 3,4 | 11,9 | 163 | 4,6 | 15,9 | 205 | 5,6 | 25,0 | 235 | 2,8 | 1,5 | 760 | 268 | 6100 | |
| | 1,7 | 5,8 | 105 | 3,9 | 7,0 | 187 | 5,3 | 9,1 | 240 | 6,0 | 21,0 | 250 | 3,9 | 2,0 | 810 | 286 | 6700 | |
| | 1,8 | 4,7 | 112 | 4,2 | 4,7 | 205 | 5,6 | 6,8 | 255 | 6,3 | 17,4 | 270 | 5,3 | 3,0 | 910 | 337 | 7900 | |
| Ln XMW 5003 | 2,0 | 3,6 | 119 | 4,6 | 3,0 | 220 | 6,0 | 5,0 | 275 | 6,7 | 14,0 | 290 | 6,0 | 4,0 | 970 | 359 | 9100 | |
| An XMW 4003 | 2,1 | 2,7 | 127 | - | - | - | 6,3 | 3,6 | 290 | 7,0 | 11,0 | 305 | - | - | - | - | - | |
| SUC 2690 | 0,9 | 31,0 | 57,0 | 2,1 | 53,0 | 96,0 | 2,7 | 80,0 | 103 | 3,8 | 88,0 | 135 | - | - | - | - | - | - |
| | 1,0 | 25,0 | 66,0 | 2,4 | 41,0 | 112 | 3,0 | 69,0 | 117 | 4,2 | 73,0 | 156 | 1,0 | 0,7 | 610 | 182 | 4900 | |
| | 1,1 | 18,5 | 75,0 | 2,7 | 31,0 | 127 | 3,2 | 59,0 | 130 | 4,6 | 61,0 | 176 | 1,8 | 1,5 | 690 | 218 | 5800 | |
| | 1,3 | 12,9 | 85,0 | 2,8 | 26,0 | 136 | 3,5 | 49,0 | 146 | 4,9 | 48,0 | 196 | 2,8 | 2,0 | 760 | 268 | 6700 | |
| | - | - | - | 3,0 | 22,0 | 144 | 3,7 | 44,0 | 154 | 5,3 | 39,0 | 215 | 3,5 | 3,0 | 790 | 278 | 7000 | |
| Ln XMW 5004 | - | - | - | - | - | - | 3,8 | 37,0 | 161 | 5,6 | 31,0 | 240 | 4,9 | 4,0 | 910 | 337 | 8500 | |
| An XMW 4003 | - | - | - | - | - | - | 3,9 | 35,0 | 170 | 6,0 | 23,0 | 260 | - | - | - | - | - | |
| SUC 3129 | 1,0 | 44,0 | 86,0 | 2,0 | 123 | 108 | 2,2 | 199 | 88,0 | 3,0 | 250 | 99,0 | - | - | - | - | - | - |
| | 1,1 | 32,0 | 102 | 2,1 | 108 | 119 | 2,5 | 174 | 110 | 3,2 | 225 | 120 | 1,0 | 0,7 | 890 | 298 | 6100 | |
| | - | - | - | 2,2 | 95,0 | 130 | 2,8 | 146 | 133 | 3,5 | 205 | 141 | 1,7 | 1,5 | 990 | 349 | 7000 | |
| | - | - | - | 2,4 | 79,0 | 143 | 3,1 | 121 | 154 | 3,8 | 182 | 163 | 2,4 | 2,0 | 1040 | 385 | 7600 | |
| | - | - | - | 2,5 | 64,0 | 155 | 3,2 | 108 | 166 | 4,1 | 159 | 184 | 3,1 | 3,0 | 1070 | 396 | 7900 | |
| Ln XMW 5005 | - | - | - | 2,7 | 52,0 | 166 | 3,4 | 95 | 176 | 4,6 | 121 | 225 | 3,8 | 4,0 | 1170 | 455 | 9100 | |
| An XMW 4004 | - | - | - | 2,8 | 42,0 | 178 | 3,5 | 84 | 187 | 4,9 | 93,0 | 255 | - | - | - | - | - | |

0,7

2,0

3,0

4,0

Liquid pressure (bar)

1/4" SIZE

PRESSURE PRINCIPLE

INTERNAL MIX SET-UPS

WIDE ANGLE FULL CONE SPRAY

These multi-orifice set-ups produce wide angle, full cone shaped, atomized sprays as a result from the combination of several narrow angle sprays.

The resulting encompassed spray angle is about 60° and more precise details on the spray dimensions are given in the table on the right side of the page.

The spray length can reach from 1.500 to 10.400 mm depending upon the set-up type and operating conditions.

See advice on adjustment for flow rates and droplet size given at page 8.

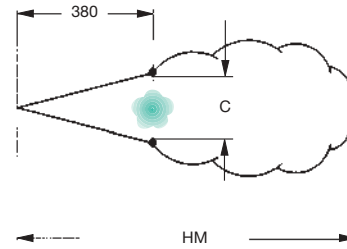

WH = Water capacity (l/hour)
AM = Air capacity (NI/min)

- Materials
 B1 AISI 303 Stainless steel
 B3 AISI 316 Stainless steel
 D1 PVC
 T8 Nickel plated brass

| Set-up Code | Air pressure (bar) | | | | | | | | | | | | | | | |
|-----------------|--------------------|------|------|------|------|-------|------|------|------|------|------|------|------|-----|-----|-------|
| | 0,7 | | 2,0 | | 3,0 | | 4,0 | | 5,0 | | PA | PL | C | HM | | |
| | WH | AM | WH | AM | WH | AM | WH | AM | WH | AM | | | | | | |
| SUL 1640 | 0,6 | 5,3 | 10,2 | 1,5 | 8,1 | 16,4 | 2,4 | 8,9 | 22,0 | 3,1 | 10,5 | 24,0 | 0,7 | 0,7 | 230 | 1500 |
| | 0,7 | 4,3 | 12,2 | 1,8 | 6,6 | 21,0 | 2,7 | 8,1 | 26,0 | 3,4 | 9,7 | 28,0 | 1,4 | 1,5 | 240 | 1800 |
| | 0,9 | 3,0 | 14,2 | 2,1 | 4,9 | 25,0 | 3,0 | 6,4 | 30,0 | 3,9 | 7,8 | 36,0 | 1,8 | 2,0 | 250 | 2100 |
| | 1,0 | 1,7 | 17,0 | 2,4 | 3,2 | 29,0 | 3,2 | 4,9 | 34,0 | 4,2 | 6,1 | 42,0 | 3,0 | 3,0 | 260 | 2700 |
| | Ln XMW 5001 | - | - | - | - | - | - | 3,4 | 4,2 | 37,0 | 4,6 | 4,4 | 47,0 | 3,9 | 4,0 | 300 |
| An XMW 4010 | - | - | - | - | - | - | 3,5 | 3,4 | 40,0 | 4,9 | 2,8 | 54,0 | - | - | - | - |
| SUM 2220 | 0,9 | 7,0 | 50,0 | 2,0 | 18,5 | 68,0 | 2,8 | 25,0 | 84,0 | 3,7 | 31,0 | 96,0 | - | - | - | - |
| | 1,0 | 2,1 | 62,0 | 2,1 | 15,1 | 76,0 | 3,0 | 22,0 | 92,0 | 3,8 | 28,0 | 105 | 0,9 | 0,7 | 310 | 1800 |
| | - | - | - | 2,2 | 11,7 | 85,0 | 3,1 | 18,5 | 101 | 3,9 | 26,0 | 113 | 1,7 | 1,5 | 330 | 2400 |
| | - | - | - | - | - | - | 3,2 | 15,1 | 109 | 4,1 | 23,0 | 122 | 2,1 | 2,0 | 330 | 3200 |
| | Ln XMW 5003 | - | - | - | - | - | - | 3,4 | 12,1 | 119 | 4,2 | 20,0 | 130 | 3,2 | 3,0 | 340 |
| An XMW 4011 | - | - | - | - | - | - | 3,5 | 9,1 | 130 | 4,6 | 13,6 | 153 | 4,1 | 4,0 | 370 | 5900 |
| - | - | - | - | - | - | - | 3,7 | 6,1 | 142 | 4,9 | 6,8 | 183 | - | - | - | - |
| SUL 2330 | 1,1 | 12,3 | 40,0 | 2,7 | 21,0 | 69,0 | 4,2 | 19,3 | 100 | 5,6 | 22,0 | 130 | - | - | - | - |
| | 1,3 | 9,9 | 45,0 | 3,0 | 16,3 | 78,0 | 4,6 | 14,6 | 113 | 6,0 | 17,6 | 142 | 1,5 | 0,7 | 230 | 2700 |
| | 1,4 | 7,9 | 50,0 | 3,2 | 12,3 | 86,0 | 4,9 | 10,8 | 124 | 6,3 | 14,0 | 152 | 3,0 | 1,5 | 240 | 4600 |
| | 1,5 | 6,1 | 54,0 | 3,4 | 10,7 | 91,0 | 5,3 | 8,1 | 135 | 6,7 | 11,4 | 163 | 3,4 | 2,0 | 240 | 5500 |
| | Ln XMW 5003 | 1,7 | 4,9 | 58,0 | 3,5 | 9,3 | 94,0 | 5,6 | 6,2 | 146 | 7,0 | 9,1 | 174 | 5,3 | 3,0 | 250 |
| An XMW 4013 | 1,8 | 3,9 | 62,0 | 3,9 | 6,4 | 105,0 | 6,0 | 4,9 | 157 | - | - | - | 6,3 | 4,0 | 300 | 9400 |
| - | 2,0 | 3,1 | 67,0 | 4,2 | 4,7 | 115,0 | 6,3 | 4,0 | 167 | - | - | - | - | - | - | - |
| SUM 2460 | 0,7 | 24,0 | 32,0 | 2,1 | 33,0 | 66,0 | 2,8 | 52,0 | 65,0 | 3,7 | 63,0 | 68,0 | - | - | - | - |
| | 0,9 | 13,6 | 44,0 | 2,2 | 26,0 | 78,0 | 3,0 | 46,0 | 76,0 | 3,8 | 58,0 | 79,0 | 0,9 | 0,7 | 360 | 2100 |
| | 1,0 | 7,6 | 57,0 | 2,4 | 18,9 | 89,0 | 3,1 | 39,0 | 87,0 | 3,9 | 52,0 | 101 | 1,5 | 1,5 | 370 | 3200 |
| | - | - | - | 2,5 | 11,7 | 100 | 3,2 | 33,0 | 99,0 | 4,2 | 41,0 | 111 | 2,4 | 2,0 | 370 | 4100 |
| | Ln XMW 5004 | - | - | - | - | - | - | 3,4 | 26,0 | 110 | 4,6 | 27,0 | 138 | 3,2 | 3,0 | 380 |
| An XMW 4011 | - | - | - | - | - | - | 3,5 | 19,5 | 122 | 4,9 | 15,9 | 166 | 3,9 | 4,0 | 390 | 6800 |
| - | - | - | - | - | - | - | 3,7 | 13,2 | 133 | - | - | - | - | - | - | - |
| SUM 2860 | 1,3 | 36,0 | 85,0 | 3,1 | 53,0 | 156 | 4,2 | 64,0 | 197 | 5,6 | 74,0 | 245 | - | - | - | - |
| | 1,5 | 29,0 | 102 | 3,2 | 50,0 | 163 | 4,9 | 51,0 | 230 | 6,0 | 68,0 | 260 | 2,0 | 0,7 | 330 | 5500 |
| | 1,8 | 23,0 | 117 | 3,4 | 47,0 | 170 | 5,6 | 40,0 | 265 | 6,3 | 62,0 | 280 | 3,0 | 1,5 | 340 | 6400 |
| | 2,0 | 19,7 | 125 | 3,5 | 45,0 | 177 | 6,0 | 34,0 | 285 | 6,7 | 56,0 | 295 | 3,9 | 2,0 | 370 | 8200 |
| | Ln XMW 5004 | 2,1 | 16,7 | 133 | 3,9 | 38,0 | 194 | 6,3 | 28,0 | 300 | 7,0 | 51,0 | 315 | 6,0 | 3,0 | 380 |
| An XMW 4012 | 2,3 | 14,0 | 142 | 4,6 | 25,0 | 230 | 6,7 | 22,0 | 320 | - | - | - | 6,3 | 4,0 | 410 | 10400 |
| - | 2,4 | 11,4 | 149 | 4,9 | 18,5 | 245 | 7,0 | 17,8 | 335 | - | - | - | - | - | - | - |
| SUQ 3140 | 1,7 | 25,0 | 156 | 3,4 | 50,0 | 250 | 4,6 | 62,0 | 320 | 6,0 | 93,0 | 395 | 2,0 | 0,7 | 460 | 5500 |
| | 1,8 | 19,7 | 167 | 3,5 | 43,0 | 260 | 4,9 | 47,0 | 345 | 6,3 | 77,0 | 425 | 3,2 | 1,5 | 470 | 6400 |
| | 2,0 | 15,1 | 178 | 3,7 | 41,0 | 275 | 5,3 | 36,0 | 375 | 6,7 | 62,0 | 460 | 3,9 | 2,0 | 510 | 7300 |
| | 2,1 | 11,4 | 193 | 3,9 | 27,0 | 300 | 5,6 | 26,0 | 405 | 7,0 | 52,0 | 495 | 5,3 | 3,0 | 530 | 7900 |
| | Ln XMW 5005 | 2,3 | 7,6 | 205 | 4,1 | 23,0 | 310 | 6,0 | 18,9 | 435 | - | - | - | 6,3 | 4,0 | 580 |
| An XMW 4014 | - | - | - | 4,2 | 18,9 | 320 | 6,3 | 13,6 | 460 | - | - | - | - | - | - | - |
| - | - | - | - | 4,4 | 15,9 | 335 | - | - | - | - | - | - | - | - | - | - |

0,7

2,0

3,0

4,0

Liquid pressure (bar)

PRESSURE PRINCIPLE

1/4" SIZE

INTERNAL MIX SET-UPS

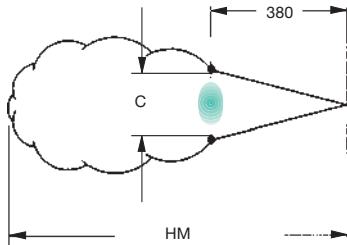

FLAT SPRAY

These single orifice set-ups produce flat fan shaped atomized sprays. More precise details on the spray dimensions are given in the table on the right side of the page.

The spray length can reach from 1.800 to 5.200 mm depending upon the set-up type and operating conditions.

See advice on adjustment for flow rates and droplet size given at page 8.

WH = Water capacity (l/hour)
AM = Air capacity (NI/min)

Materials
B1 AISI 303 Stainless steel
B3 AISI 316 Stainless steel
D1 PVC
T8 Nickel plated brass

| Set-up Code | Air pressure (bar) | | | | | | | | | | | | | | | | |
|-----------------|----------------------------|------|-----|-----|------|------|-----|------|------|-----|------|------|-----|-----|-----|------|------|
| | | 0,7 | | 2,0 | | 3,0 | | 4,0 | | PA | PL | C | HM | | | | |
| | | WH | AM | WH | AM | WH | AM | WH | AM | | | | | | | | |
| SUU 2101 | 0,7 | 5,5 | 24 | 2,0 | 8,6 | 42 | 2,7 | 11,2 | 52 | 3,9 | 12 | 69 | 1,1 | 0,7 | 460 | 2600 | |
| | 0,9 | 4,7 | 27 | 2,2 | 7,5 | 47 | 3,0 | 10,1 | 56 | 4,6 | 9,7 | 81 | 2,1 | 1,5 | 660 | 3000 | |
| | 1,0 | 4,1 | 31 | 2,5 | 6,2 | 52 | 3,2 | 9,1 | 62 | 5,3 | 7,5 | 93 | 2,8 | 2,0 | 760 | 3200 | |
| | 1,1 | 3,5 | 34 | 2,8 | 5,2 | 57 | 3,5 | 8,1 | 66 | 6,0 | 5,3 | 104 | 3,5 | 3,0 | 860 | 3400 | |
| | 1,3 | 3,0 | 37 | 3,1 | 4,2 | 63 | 4,2 | 5,4 | 79 | 6,3 | 4,3 | 110 | 6,0 | 4,0 | 940 | 4000 | |
| | Ln XMW 5001 An XMW 4020 | 1,4 | 2,5 | 40 | 3,2 | 3,7 | 65 | 4,6 | 4,2 | 85 | 6,7 | 3,3 | 116 | - | - | - | - |
| | 1,5 | 2,0 | 44 | 3,4 | 3,2 | 68 | 4,9 | 3,1 | 91 | 7,0 | 2,4 | 122 | - | - | - | - | |
| SUU 2160 | 1,3 | 3,9 | 30 | 3,0 | 6,1 | 52 | 3,9 | 9,4 | 60 | 5,3 | 10,2 | 78 | 1,5 | 0,7 | 460 | 1800 | |
| | 1,4 | 3,0 | 33 | 3,1 | 5,3 | 54 | 4,2 | 7,2 | 67 | 5,6 | 8,3 | 84 | 2,7 | 1,5 | 690 | 2000 | |
| | 1,5 | 2,3 | 35 | 3,2 | 4,5 | 57 | 4,6 | 5,3 | 73 | 6,0 | 6,6 | 89 | 3,2 | 2,0 | 910 | 2000 | |
| | 1,7 | 1,8 | 38 | 3,4 | 3,8 | 59 | 4,9 | 3,8 | 80 | 6,3 | 5,1 | 98 | 4,2 | 3,0 | 940 | 2100 | |
| | Ln XMW 5002 An XMW 4022 | 1,8 | 1,3 | 41 | 3,5 | 3,2 | 62 | - | - | - | - | - | - | 5,6 | 4,0 | 970 | 2300 |
| | | 2,0 | 1,0 | 44 | 3,9 | 1,8 | 68 | - | - | - | - | - | - | - | - | - | - |
| SUM 2167 | 1,0 | 9,0 | 25 | 2,4 | 11,6 | 48 | 3,1 | 15,6 | 56 | 4,2 | 17,1 | 73 | 1,4 | 0,7 | 170 | 3000 | |
| | 1,1 | 7,8 | 30 | 2,5 | 10,4 | 51 | 3,2 | 14,6 | 59 | 4,6 | 15 | 80 | 2,5 | 1,5 | 200 | 3700 | |
| | 1,3 | 6,6 | 32 | 2,7 | 9,40 | 54 | 3,4 | 13,7 | 62 | 4,9 | 12,8 | 87 | 3,2 | 2,0 | 220 | 4000 | |
| | 1,4 | 5,2 | 36 | 3,0 | 7,30 | 61 | 3,8 | 10,8 | 71 | 5,3 | 11 | 94 | 3,8 | 3,0 | 280 | 4200 | |
| | 1,7 | 3,1 | 44 | 3,2 | 5,50 | 68 | 4,2 | 8,5 | 82 | 5,6 | 9,4 | 103 | 5,3 | 4,0 | 330 | 4800 | |
| | Ln XMW 5002 An XMW 4021 | 2,0 | 2,0 | 50 | 3,5 | 4,10 | 75 | 4,9 | 5,2 | 98 | 6,3 | 7,2 | 119 | - | - | - | - |
| | | 2,2 | 1,1 | 56 | 3,8 | 2,90 | 81 | 6,0 | 2,3 | 120 | 7,0 | 6,1 | 134 | - | - | - | - |
| | | | | | | | | | | | | | | | | | |
| SUU 2171 | 0,9 | 8,2 | 20 | 2,1 | 13,5 | 36 | 2,7 | 19,1 | 42 | 4,6 | 16,1 | 69 | 1,1 | 0,7 | 710 | 2100 | |
| | 1,0 | 6,8 | 23 | 2,4 | 11,4 | 42 | 3,0 | 17,1 | 46 | 4,9 | 13,8 | 76 | 2,1 | 1,5 | 810 | 2400 | |
| | 1,1 | 5,5 | 27 | 2,7 | 9,20 | 47 | 3,2 | 15,1 | 52 | 5,3 | 11,5 | 83 | 3,0 | 2,0 | 890 | 2600 | |
| | 1,3 | 4,1 | 30 | 3,0 | 7,10 | 53 | 3,5 | 13,1 | 57 | 5,6 | 9,3 | 90 | 3,5 | 3,0 | 970 | 2700 | |
| | 1,4 | 2,9 | 34 | 3,2 | 5,00 | 59 | 4,2 | 8,1 | 72 | 6,0 | 7,3 | 97 | 5,6 | 4,0 | 970 | 3200 | |
| | Ln XMW 5002 An XMW 4020 | - | - | - | 3,4 | 4,00 | 63 | 4,6 | 5,9 | 79 | 6,3 | 5,6 | 104 | - | - | - | - |
| | - | - | - | 3,5 | 3,30 | 66 | 4,9 | 4,0 | 86 | 6,7 | 4,3 | 112 | - | - | - | - | |
| SUM 2320 | 1,1 | 11,2 | 54 | 2,7 | 19,6 | 93 | 3,5 | 27 | 112 | 4,6 | 33 | 137 | 1,4 | 0,7 | 200 | 3000 | |
| | 1,3 | 8,5 | 60 | 2,8 | 17,3 | 98 | 3,7 | 25 | 116 | 4,9 | 28 | 149 | 2,4 | 1,5 | 330 | 3200 | |
| | 1,4 | 6,5 | 65 | 3,0 | 15,2 | 103 | 3,8 | 23 | 121 | 5,3 | 24 | 161 | 3,0 | 2,0 | 460 | 3400 | |
| | 1,5 | 5,0 | 71 | 3,1 | 13,2 | 109 | 3,9 | 21 | 126 | 5,6 | 19,7 | 174 | 3,7 | 3,0 | 460 | 3500 | |
| | 1,7 | 3,8 | 77 | 3,2 | 11,4 | 114 | 4,1 | 18,9 | 132 | 6,0 | 15,7 | 187 | 5,3 | 4,0 | 480 | 4000 | |
| | Ln XMW 5003 An XMW 4024 | - | - | - | - | - | - | 4,2 | 17 | 137 | 6,3 | 12,4 | 200 | - | - | - | - |
| SUM 2600 | 1,0 | 17,0 | 23 | 2,4 | 28,0 | 51 | 3,4 | 38 | 72 | 3,9 | 65 | 75 | 1,1 | 0,7 | 150 | 2400 | |
| | 1,1 | 11,0 | 27 | 2,5 | 23,0 | 59 | 3,5 | 33 | 80 | 4,2 | 53 | 89 | 2,1 | 1,5 | 170 | 3000 | |
| | 1,3 | 7,6 | 33 | 2,7 | 18,9 | 66 | 3,7 | 28 | 89 | 4,6 | 40 | 108 | 2,8 | 2,0 | 220 | 3400 | |
| | 1,4 | 3,2 | 40 | 2,8 | 15,1 | 74 | 3,8 | 23 | 97 | 4,9 | 30 | 127 | 3,7 | 3,0 | 280 | 3600 | |
| | - | - | - | 3,0 | 11,7 | 79 | 3,9 | 19,7 | 105 | 5,3 | 21 | 149 | 4,9 | 4,0 | 350 | 4000 | |
| | Ln XMW 5004 An XMW 4023 | - | - | - | - | - | - | 4,2 | 13,1 | 120 | 5,6 | 13,8 | 173 | - | - | - | - |
| | - | - | - | - | - | - | 4,6 | 7,2 | 138 | 6,3 | 3,2 | 225 | - | - | - | - | |
| SUQ 2700 | 0,9 | 27,0 | 33 | 2,4 | 39,0 | 67 | 3,2 | 58 | 76 | 4,6 | 59 | 106 | 1,1 | 0,7 | 300 | 3400 | |
| | 1,0 | 20,0 | 38 | 2,7 | 30,0 | 77 | 3,5 | 47 | 87 | 5,3 | 40 | 132 | 2,4 | 1,5 | 410 | 3500 | |
| | 1,1 | 15,9 | 45 | 3,0 | 24,0 | 87 | 3,8 | 38 | 97 | 5,6 | 32 | 145 | 3,2 | 2,0 | 430 | 3700 | |
| | 1,3 | 12,5 | 48 | 3,2 | 17,8 | 98 | 3,9 | 34 | 103 | 6,0 | 26 | 158 | 3,9 | 3,0 | 480 | 3800 | |
| | 1,4 | 10,2 | 56 | 3,4 | 15,1 | 103 | 4,2 | 27 | 113 | 6,3 | 20 | 172 | 6,0 | 4,0 | 510 | 4400 | |
| | Ln XMW 5004 An XMW 4024 | 1,5 | 7,6 | 62 | 3,5 | 12,9 | 109 | 4,6 | 20 | 126 | 6,7 | 15,9 | 185 | - | - | - | - |
| | - | - | - | 3,7 | 10,6 | 114 | 4,9 | 14,8 | 140 | 7,0 | 12,7 | 198 | - | - | - | - | |
| SUQ 3126 | 1,0 | 29,0 | 90 | 2,1 | 100 | 119 | 3,0 | 126 | 140 | 4,1 | 140 | 181 | 1,0 | 0,7 | 250 | 3400 | |
| | 1,1 | 18,9 | 108 | 2,2 | 79,0 | 133 | 3,1 | 110 | 151 | 4,2 | 125 | 193 | 1,8 | 1,5 | 430 | 3800 | |
| | - | - | - | 2,4 | 62,0 | 147 | 3,2 | 95 | 163 | 4,6 | 89 | 225 | 2,4 | 2,0 | 460 | 4300 | |
| | - | - | - | 2,5 | 48,0 | 162 | 3,4 | 78 | 184 | 4,9 | 58 | 265 | 3,4 | 3,0 | 530 | 4600 | |
| | - | - | - | 2,7 | 36,0 | 177 | 3,5 | 62 | 193 | 5,3 | 34 | 305 | 4,9 | 4,0 | 580 | 5200 | |
| | Ln XMW 5005 | - | - | - | - | - | - | 3,7 | 48 | 210 | 5,6 | 16,7 | 340 | - | - | - | - |
| | An XMW 4025 | - | - | - | - | - | - | 3,8 | 37 | 225 | - | - | - | - | - | - | - |
| | | - | - | - | - | - | - | - | - | - | - | - | - | - | - | - | - |



1/4" SIZE

SIPHON PRINCIPLE

INTERNAL MIX SET-UPS

ROUND AND FLAT SPRAYS

These set-ups are designed to work with a liquid fed out of an ambient pressure container, either by liquid siphoning or by gravity head. Therefore the performance tables give the water flow rate for both suction head (green background) and gravity head (white background). The approximate spray depending upon set-up type and operating conditions are given from the table at the right, while advice about adjustment for flow rates and droplet sizes given at page 8.

- Materials
B1 AISI 303 Stainless steel
B3 AISI 316 Stainless steel
D1 PVC
T8 Nickel plated brass

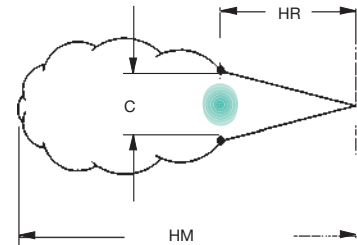

WH = Water capacity (l/hour)
 AM = Air capacity (NI/min)



| Set-up Code | Air pressure (bar) | | Air capacity (NI/min) | | | | | | | | Full cone spray | | | |
|-----------------|--------------------|-----|--------------------------|------|------|------|------|------|------|-----|-----------------|-----|-----|------|
| | 0,7 | 11 | Liquid capacity (l/hour) | | | | | | | | PA | HR | C | HM |
| | | | 1,5 | 1,3 | 1,1 | 0,9 | 0,7 | 0,5 | - | - | | | | |
| SUC 1120 | 0,7 | 11 | 1,5 | 1,3 | 1,1 | 0,9 | 0,7 | 0,5 | - | - | 0,7 | 280 | 89 | 1800 |
| Ln XMW 5006 | 1,5 | 17 | 1,8 | 1,7 | 1,5 | 1,3 | 1,2 | 1,1 | 0,6 | - | 1,5 | 280 | 89 | 1900 |
| An XMW 4040 | 3,0 | 28 | 2,1 | 1,9 | 1,7 | 1,5 | 1,4 | 1,3 | 1,1 | 0,8 | 3,0 | 300 | 95 | 2300 |
| | 4,0 | 36 | 2,2 | 2,0 | 1,8 | 1,6 | 1,5 | 1,4 | 1,2 | 0,9 | 4,0 | 360 | 114 | 2600 |
| SUC 1190 | 0,7 | 13 | 2,4 | 2,1 | 1,7 | 1,5 | 1,2 | 0,8 | - | - | 0,7 | 300 | 95 | 2100 |
| Ln XMW 5001 | 1,5 | 20 | 2,8 | 2,6 | 2,4 | 2,1 | 1,9 | 1,6 | 0,9 | - | 1,5 | 330 | 104 | 2300 |
| An XMW 4040 | 3,0 | 32 | 3,4 | 3,1 | 2,9 | 2,8 | 2,6 | 2,4 | 1,7 | 1,1 | 3,0 | 380 | 120 | 2600 |
| | 4,0 | 41 | 3,7 | 3,4 | 3,3 | 3,1 | 2,9 | 2,7 | 2,1 | 1,5 | 4,0 | 430 | 144 | 3000 |
| SUC 1200 | 0,7 | 23 | 2,5 | 2,3 | 2,0 | 1,6 | 1,4 | 1,1 | - | - | 0,7 | 300 | 95 | 2400 |
| Ln XMW 5001 | 1,5 | 36 | 2,9 | 2,8 | 2,5 | 2,2 | 2,0 | 1,7 | 0,9 | - | 1,5 | 330 | 104 | 2700 |
| An XMW 4041 | 3,0 | 58 | 3,4 | 3,3 | 3,2 | 2,9 | 2,8 | 2,5 | 1,9 | 1,2 | 3,0 | 380 | 127 | 3400 |
| | 4,0 | 74 | 3,7 | 3,6 | 3,5 | 3,4 | 3,3 | 3,0 | 2,5 | 2,0 | 4,0 | 430 | 151 | 4000 |
| SUC 1290 | 0,7 | 19 | 4,5 | 4,0 | 3,4 | 2,1 | 1,8 | 1,4 | - | - | 0,7 | 380 | 140 | 3000 |
| Ln XMW 5002 | 1,5 | 31 | 5,3 | 4,9 | 4,4 | 3,5 | 2,9 | 2,7 | 1,8 | - | 1,5 | 410 | 152 | 3400 |
| An XMW 4041 | 3,0 | 50 | 6,0 | 5,6 | 5,0 | 4,4 | 4,0 | 3,4 | 2,4 | 1,2 | 3,0 | 460 | 170 | 4000 |
| | 4,0 | 65 | 5,7 | 5,4 | 5,0 | 4,2 | 3,9 | 3,5 | 2,8 | 1,9 | 4,0 | 510 | 198 | 4600 |
| SUC 2105 | 1,5 | 58 | 22,0 | 19,9 | 16,3 | 12,3 | 10,5 | 8,3 | 2,8 | - | 1,5 | 460 | 137 | 3700 |
| Ln XMW 5004 | 3,0 | 88 | 25,0 | 23,0 | 19,5 | 16,7 | 14,2 | 11,5 | 6,4 | 2,8 | 3,0 | 510 | 161 | 4300 |
| An XMW 4042 | 4,0 | 111 | 26,0 | 24,0 | 21,0 | 18,4 | 15,7 | 12,9 | 7,9 | 4,5 | 4,0 | 530 | 168 | 4900 |
| | 5,6 | 147 | 26,0 | 24,0 | 22,0 | 19,7 | 17,0 | 14,6 | 9,8 | 6,1 | 5,6 | 580 | 194 | 5500 |
| SUC 2180 | 2,0 | 144 | - | - | - | 27,0 | 22,0 | 16,8 | - | - | 2,0 | 510 | 180 | 6700 |
| Ln XMW 5005 | 3,0 | 190 | - | - | - | 30,0 | 26,0 | 21,0 | - | - | 3,0 | 530 | 187 | 7000 |
| An XMW 4043 | 4,0 | 240 | - | 43,0 | 40,0 | 31,0 | 28,0 | 23,0 | 11,0 | - | 4,0 | 580 | 215 | 7600 |
| | 5,6 | 315 | 44,0 | 42,0 | 39,0 | 31,0 | 28,0 | 24,0 | 16,7 | 8,3 | 5,6 | 630 | 245 | 8200 |

| | | | | | | | |
|-------------------|-----|-----|-------------------|-----|-----|-----|-----|
| 450 | 300 | 150 | 100 | 200 | 300 | 600 | 900 |
| Gravity head (mm) | | | Suction head (mm) | | | | |

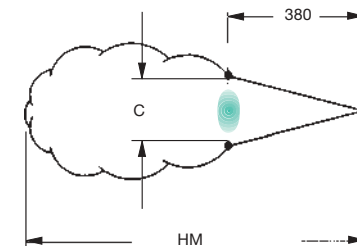

WH = Water capacity (l/hour)
 AM = Air capacity (NI/min)

| Set-up Code | Air pressure (bar) | | Air capacity (NI/min) | | | | | | | | Flat fan spray | | |
|-----------------|--------------------|-----|--------------------------|-----|-----|-----|-----|-----|-----|-----|----------------|-----|------|
| | 0,7 | 28 | Liquid capacity (l/hour) | | | | | | | | PA | C | HM |
| | | | 1,3 | 1,2 | 1,1 | 1,0 | 1,0 | 0,8 | 0,6 | 0,5 | | | |
| SUQ 0860 | 0,7 | 28 | 1,3 | 1,2 | 1,1 | 1,0 | 1,0 | 0,8 | 0,6 | 0,5 | 0,7 | 380 | 2100 |
| Ln XMW 5002 | 1,5 | 43 | 1,2 | 1,1 | 1,0 | 0,9 | 0,9 | 0,8 | 0,7 | 0,5 | 1,5 | 380 | 2100 |
| An XMW 4026 | 2,0 | 50 | 0,8 | 0,8 | 0,7 | 0,6 | 0,5 | - | - | - | 2,0 | 380 | 1800 |
| SUQ 1280 | 1,5 | 56 | 3,7 | 3,5 | 3,3 | 2,9 | 2,8 | 2,5 | 2,3 | 2,1 | 1,5 | 380 | 2700 |
| Ln XMW 5007 | 2,0 | 65 | 3,4 | 3,3 | 3,1 | 2,8 | 2,7 | 2,6 | 2,4 | 2,2 | 2,0 | 420 | 2700 |
| An XMW 4027 | 3,0 | 87 | 2,8 | 2,7 | 2,5 | 2,4 | 2,2 | 2,1 | 1,9 | 1,7 | 3,0 | 460 | 3000 |
| | 4,0 | 110 | 1,9 | 1,8 | 1,6 | 1,5 | 1,3 | 1,2 | - | - | 4,0 | 480 | 2700 |
| SUQ 1370 | 1,5 | 68 | 5,1 | 4,8 | 4,5 | 3,8 | 3,7 | 3,5 | 3,0 | 2,4 | 1,5 | 270 | 3400 |
| Ln XMW 5003 | 2,0 | 78 | 4,9 | 4,7 | 4,4 | 3,6 | 3,4 | 3,2 | 2,9 | 2,3 | 2,0 | 280 | 3400 |
| An XMW 4028 | 3,0 | 103 | 3,4 | 3,2 | 3,0 | 2,2 | 2,0 | 1,7 | - | - | 3,0 | 300 | 3000 |
| | 3,5 | 117 | 2,2 | 2,0 | 1,7 | - | - | - | - | - | - | - | - |
| SUQ 1540 | 1,5 | 63 | 7,6 | 7,2 | 6,6 | 5,7 | 5,4 | 5,1 | 4,6 | 3,7 | 1,5 | 270 | 3400 |
| Ln XMW 5003 | 2,0 | 73 | 7,6 | 7,3 | 6,8 | 5,9 | 5,7 | 5,5 | 5,0 | 4,2 | 2,0 | 290 | 3400 |
| An XMW 4029 | 3,0 | 96 | 6,4 | 6,1 | 5,7 | 5,0 | 4,5 | 4,1 | 3,3 | - | 3,0 | 330 | 3400 |
| | 3,5 | 110 | 4,2 | 3,7 | 3,2 | 2,6 | - | - | - | - | - | - | - |

| | | | | | | | |
|-------------------|-----|-----|-------------------|-----|-----|-----|-----|
| 450 | 300 | 150 | 100 | 200 | 300 | 600 | 900 |
| Gravity head (mm) | | | Suction head (mm) | | | | |



PRESSURE PRINCIPLE

1/4" SIZE

EXTERNAL MIX

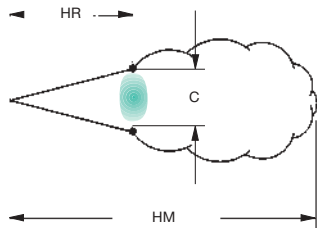

WH = Water capacity (l/hour)
AM = Air capacity (NI/min)

FLAT FAN SPRAY

These set-ups are designed in order to have two different paths for air and liquid, and to eject them through different orifices, so that the atomized spray is produced from their impact in the immediate surroundings of the orifices. It is possible therefore to atomize viscous liquids as well as any liquid which might originate a solid build up in the mixing chamber of an ordinary internal mix atomizer.

In addition liquid and air pressure can be adjusted independently from each other, which allows for an easy steady state atomizer regulation.

The approximate spray depending upon set-up type and operating conditions are given from the table at the right, while advice about adjustment for flow rates and droplet sizes given at page 8.

- Materials**
- B1 AISI 303 Stainless steel
 - B3 AISI 316 Stainless steel
 - D1 PVC
 - T8 Nickel plated brass

| Set-up Code | Air pressure (bar) | | | | | | | | | | | | | | | | | | | |
|---|--------------------|------|-----|-----|------|-----|-----|------|-----|-----|------|-----|-----|------|-----|-----|-----|------|------|-----|
| | WH | | AM | | WH | | AM | | WH | | AM | | WH | | AM | | PA | PL | C | HM |
| SUL 2110 Ln XMW 5006 An XMW 4030 | 0,2 | | 25 | 0,4 | | 26 | 0,7 | | 31 | 1,4 | | 45 | 2,8 | | 74 | 0,2 | 0,2 | 230 | 900 | 150 |
| | 0,4 | | 26 | 0,7 | | 31 | 1,1 | | 40 | 1,8 | | 54 | 3,5 | | 85 | 1,1 | 0,2 | 230 | 1200 | 150 |
| | 0,7 | | 31 | 1,1 | | 40 | 1,4 | | 45 | 2,1 | | 60 | 4,2 | | 102 | 1,4 | 0,4 | 230 | 1200 | 150 |
| | 1,1 | 2,8 | 40 | 1,4 | 3,5 | 45 | 1,8 | 5,3 | 54 | 2,8 | 7,8 | 74 | 4,9 | 11 | 119 | 1,4 | 1,4 | 250 | 1500 | 180 |
| | 1,4 | | 45 | 1,8 | | 54 | 2,1 | | 59 | 3,5 | | 85 | 5,3 | | 128 | 1,8 | 0,7 | 240 | 1500 | 150 |
| | 1,8 | | 54 | 2,1 | | 59 | 2,8 | | 74 | 4,2 | | 102 | 5,6 | | 139 | 2,8 | 1,4 | 280 | 1800 | 180 |
| 2,1 | | 59 | 2,8 | | 74 | 3,5 | | 85 | 5,6 | | 139 | 6,3 | | 159 | 4,9 | 2,8 | 240 | 2400 | 180 | |
| SUT 2111 Ln XMW 5006 An XMW 4031 | 0,4 | | 22 | 0,4 | | 22 | 0,4 | | 25 | 0,6 | | 28 | 0,7 | | 34 | 0,6 | 0,7 | 400 | 1800 | 300 |
| | 0,5 | | 25 | 0,5 | 3,5 | 25 | 0,6 | 5,3 | 28 | 0,7 | 7,8 | 34 | 1,1 | 11 | 45 | 0,6 | 1,5 | 460 | 1800 | 350 |
| | 0,5 | | 27 | 0,6 | | 28 | 0,7 | | 34 | 1,1 | | 45 | 1,8 | | 62 | 1,4 | 1,5 | 410 | 2700 | 300 |
| | 0,6 | | 28 | 0,7 | | 34 | 0,9 | | 40 | 1,4 | | 54 | 2,5 | | 79 | 1,1 | 2,0 | 480 | 2600 | 350 |
| SUR 2166 Ln XMW 5001 An XMW 4030 | 0,4 | | 26 | 0,7 | | 31 | 1,1 | | 40 | 1,8 | | 54 | 3,2 | | 82 | 0,4 | 0,2 | 220 | 1000 | 140 |
| | 0,7 | | 31 | 1,1 | | 40 | 1,4 | | 45 | 2,1 | | 59 | 3,5 | | 85 | 1,4 | 0,2 | 220 | 1700 | 150 |
| | 1,1 | | 40 | 1,4 | | 45 | 1,8 | | 54 | 2,8 | | 74 | 4,2 | | 102 | 1,8 | 0,4 | 230 | 1800 | 165 |
| | 1,4 | 4,5 | 45 | 1,8 | 5,5 | 54 | 2,1 | 8,3 | 59 | 3,5 | 12,2 | 85 | 4,9 | 16,6 | 119 | 1,8 | 1,4 | 290 | 2100 | 190 |
| | 1,8 | | 54 | 2,1 | | 59 | 2,8 | | 74 | 4,2 | | 102 | 5,3 | | 127 | 2,1 | 0,7 | 250 | 1800 | 180 |
| | 2,1 | | 59 | 2,8 | | 74 | 3,5 | | 85 | 4,9 | | 119 | 6,3 | | 159 | 3,5 | 1,4 | 300 | 2400 | 220 |
| 2,8 | | 74 | 3,5 | | 85 | 4,2 | | 102 | 6,3 | | 159 | 6,7 | | 164 | 5,3 | 2,8 | 250 | 3000 | 190 | |
| SUV 2172 Ln XMW 5001 An XMW 4031 | 0,4 | | 22 | 0,4 | | 22 | 0,6 | | 28 | 0,7 | | 34 | 1,1 | | 45 | 0,7 | 1,5 | 580 | 1800 | 460 |
| | 0,6 | | 28 | 0,7 | 5,5 | 34 | 0,7 | 8,3 | 34 | 1,4 | 12,2 | 54 | 1,4 | 17,2 | 54 | 1,4 | 1,5 | 560 | 2400 | 430 |
| | 0,7 | | 34 | 1,1 | | 45 | 1,4 | | 54 | 2,1 | | 71 | 2,1 | | 71 | 1,8 | 2,0 | 580 | 2700 | 460 |
| | 1,1 | | 45 | 1,4 | | 54 | 2,1 | | 71 | 2,5 | | 79 | 2,5 | | 79 | 1,8 | 3,0 | 660 | 2900 | 480 |
| SUS 2330 Ln XMW 5002 An XMW 4030 | 0,7 | | 31 | 1,1 | | 40 | 1,4 | | 45 | 2,5 | | 68 | 3,5 | | 85 | 0,7 | 0,2 | 250 | 1200 | 165 |
| | 1,1 | | 40 | 1,4 | | 45 | 1,8 | | 54 | 2,8 | | 74 | 4,2 | | 102 | 1,8 | 0,2 | 250 | 1800 | 165 |
| | 1,4 | | 45 | 1,8 | | 54 | 2,1 | | 59 | 3,5 | | 85 | 4,9 | | 119 | 2,1 | 0,4 | 240 | 1800 | 180 |
| | 1,8 | 8,5 | 54 | 2,1 | 10,4 | 59 | 2,8 | 15,9 | 74 | 4,2 | 23 | 102 | 5,3 | 33 | 127 | 2,5 | 1,4 | 320 | 1800 | 200 |
| | 2,1 | | 59 | 2,8 | | 74 | 3,5 | | 85 | 4,9 | | 119 | 5,6 | | 139 | 2,8 | 0,7 | 300 | 2300 | 190 |
| | 2,8 | | 74 | 3,5 | | 85 | 4,2 | | 102 | 5,6 | | 139 | 6,3 | | 159 | 4,2 | 1,4 | 360 | 3000 | 200 |
| 3,5 | | 85 | 4,2 | | 102 | 4,9 | | 119 | 6,3 | | 159 | 7,0 | | 176 | 5,3 | 2,8 | 300 | 4000 | 200 | |
| SUV 2331 Ln XMW 5002 An XMW 4031 | 0,4 | | 25 | 0,4 | | 25 | 0,4 | | 25 | 0,7 | | 34 | 1,4 | | 54 | 0,6 | 0,7 | 630 | 1500 | 480 |
| | 0,5 | | 27 | 0,6 | 10,4 | 28 | 0,6 | 15,9 | 28 | 0,9 | 23 | 40 | 1,8 | 33 | 62 | 0,7 | 1,5 | 630 | 1800 | 480 |
| | 0,6 | | 28 | 0,7 | | 31 | 0,7 | | 34 | 1,1 | | 45 | 2,1 | | 71 | 1,4 | 1,5 | 660 | 2400 | 530 |
| | 0,7 | | 34 | 0,8 | | 34 | 0,9 | | 40 | 1,4 | | 54 | 2,5 | | 79 | 1,8 | 2,0 | 690 | 2700 | 510 |
| SUQ 2520 Ln XMW 5007 An XMW 4032 | 0,7 | | 85 | 1,0 | | 102 | 1,4 | | 116 | 2,5 | | 178 | 3,2 | | 212 | 0,7 | 0,2 | 250 | 1700 | 190 |
| | 1,0 | | 102 | 1,4 | | 116 | 1,8 | | 139 | 2,8 | | 195 | 3,5 | | 232 | 1,8 | 0,2 | 250 | 2700 | 190 |
| | 1,4 | | 116 | 1,8 | | 139 | 2,1 | | 156 | 3,5 | | 227 | 3,9 | | 255 | 2,1 | 0,4 | 280 | 3000 | 190 |
| | 1,8 | 13,4 | 139 | 2,1 | 16,4 | 156 | 2,5 | 25 | 178 | 4,2 | 37 | 266 | 4,2 | 52 | 275 | 2,5 | 0,7 | 280 | 3500 | 220 |
| | 2,1 | | 156 | 2,8 | | 195 | 2,8 | | 195 | 4,9 | | 312 | 4,9 | | 314 | 2,5 | 1,4 | 360 | 3700 | 230 |
| | 2,8 | | 195 | 3,5 | | 227 | 3,5 | | 227 | 5,6 | | 360 | 5,6 | | 360 | 4,2 | 1,4 | 370 | 4300 | 230 |
| 3,5 | | 227 | 4,2 | | 266 | 4,2 | | 266 | 6,3 | | 411 | 6,3 | | 411 | 4,9 | 2,8 | 320 | 4900 | 220 | |
| SUV 2521 Ln XMW 5007 An XMW 4033 | 0,6 | | 91 | 0,7 | | 102 | 1,4 | | 156 | 2,1 | | 210 | 3,2 | | 285 | 2,1 | 0,7 | 560 | 4300 | 400 |
| | 0,7 | | 102 | 1,1 | 16,4 | 130 | 2,1 | 25 | 210 | 2,8 | 37 | 260 | 4,2 | 52 | 360 | 2,1 | 1,5 | 580 | 4000 | 460 |
| | 1,1 | | 130 | 1,8 | | 184 | 2,5 | | 235 | 3,5 | | 310 | 5,3 | | 430 | 4,2 | 1,5 | 640 | 5200 | 480 |
| | 1,4 | | 156 | 2,1 | | 210 | 2,8 | | 260 | 4,2 | | 360 | 5,6 | | 455 | 3,9 | 2,0 | 690 | 4600 | 510 |

0,2

0,3

0,7

1,5

3,0

Liquid pressure (bar)

1/4" SIZE

PRESSURE PRINCIPLE

EXTERNAL MIX

FLAT FAN SPRAY

| Set-up Code | Air pressure (bar) | | | | | | | | | | | | | | | | | | | |
|---|--------------------|------|-----|-----|-----|-----|-----|-----|-----|-----|-----|-----|-----|-----|-----|-----|-----|------|------|-----|
| | WH | | AM | | WH | | AM | | WH | | AM | | WH | | AM | | PA | PL | C | HM |
| SUT 2680 Ln XMW 5003 An XMW 4032 | 0,7 | | 85 | 1,4 | | 116 | 1,8 | | 139 | 2,8 | | 195 | 3,5 | | 232 | 0,7 | 0,4 | 270 | 2100 | 190 |
| | 1,0 | | 102 | 1,8 | | 139 | 2,1 | | 156 | 3,2 | | 212 | 4,2 | | 275 | 1,8 | 0,7 | 270 | 3000 | 190 |
| | 1,4 | | 116 | 2,1 | | 156 | 2,5 | | 178 | 3,5 | | 227 | 4,9 | | 314 | 2,5 | 1,4 | 330 | 3400 | 220 |
| | 1,8 | 17,6 | 139 | 2,5 | 22 | 178 | 2,8 | 33 | 195 | 4,2 | 48 | 266 | 5,3 | 68 | 340 | 2,8 | 1,4 | 360 | 3800 | 220 |
| | 2,1 | | 156 | 2,8 | | 195 | 3,5 | | 227 | 4,9 | | 312 | 5,6 | | 360 | 2,8 | 1,4 | 370 | 4000 | 250 |
| | 2,8 | | 195 | 3,5 | | 227 | 4,2 | | 266 | 5,6 | | 360 | 6,3 | | 411 | 4,2 | 2,1 | 370 | 4900 | 250 |
| 3,5 | | 227 | 4,2 | | 266 | 4,9 | | 312 | 6,3 | | 411 | 6,6 | | 428 | 5,3 | 2,8 | 360 | 5800 | 230 | |
| SUV 2681 Ln XMW 5003 An XMW 4033 | 0,6 | | 91 | 0,7 | | 102 | 1,1 | | 130 | 2,5 | | 235 | 3,5 | | 310 | 1,8 | 0,7 | 640 | 3000 | 480 |
| | 1,1 | 17,6 | 130 | 1,4 | 22 | 156 | 1,8 | 33 | 184 | 3,2 | 48 | 285 | 4,6 | 68 | 380 | 2,5 | 1,5 | 640 | 3800 | 460 |
| | 1,4 | | 156 | 1,8 | | 184 | 2,5 | | 235 | 3,9 | | 330 | 6,0 | | 475 | 4,2 | 1,5 | 580 | 4900 | 430 |
| | 1,8 | | 184 | 2,1 | | 210 | 2,8 | | 260 | 4,2 | | 360 | 6,7 | | 525 | 4,2 | 2,0 | 610 | 5200 | 430 |
| SUN 3101 Ln XMW 5004 An XMW 4032 | 1,0 | | 102 | 1,8 | | 139 | 2,5 | | 178 | 3,2 | | 212 | 3,9 | | 255 | 1,0 | 0,2 | 250 | 2700 | 200 |
| | 1,4 | | 116 | 2,1 | | 156 | 2,8 | | 195 | 3,5 | | 227 | 4,2 | | 275 | 2,1 | 0,2 | 290 | 3000 | 220 |
| | 1,8 | | 139 | 2,5 | | 178 | 3,2 | | 212 | 3,9 | | 246 | 4,6 | | 297 | 2,8 | 0,4 | 360 | 3500 | 240 |
| | 2,1 | 36 | 156 | 2,8 | 45 | 195 | 3,5 | 68 | 227 | 4,2 | 100 | 266 | 4,9 | 141 | 314 | 3,2 | 1,4 | 390 | 3700 | 280 |
| | 2,5 | | 178 | 3,2 | | 212 | 4,2 | | 266 | 4,9 | | 312 | 5,6 | | 360 | 3,5 | 0,7 | 380 | 4000 | 270 |
| | 2,8 | | 195 | 3,5 | | 227 | 4,9 | | 312 | 5,6 | | 360 | 6,3 | | 411 | 4,2 | 1,4 | 390 | 4800 | 280 |
| 3,5 | | 227 | 4,2 | | 266 | 5,6 | | 360 | 6,3 | | 411 | 7,0 | | 453 | 5,6 | 2,8 | 380 | 5900 | 240 | |
| SUN 3102 Ln XMW 5008 An XMW 4034 | 1,8 | | 235 | 1,8 | | 235 | 2,5 | | 300 | 3,9 | | 410 | | | | 1,8 | 0,2 | 290 | 3000 | 200 |
| | 2,1 | | 260 | 2,1 | | 260 | 2,8 | | 330 | 4,2 | | 445 | | | | 2,8 | 0,2 | 300 | 3400 | 200 |
| | 2,5 | | 300 | 2,5 | | 300 | 3,2 | | 355 | 4,6 | | 480 | | | | 2,8 | 0,3 | 300 | 4000 | 200 |
| | 2,8 | 36 | 330 | 2,8 | 45 | 330 | 3,5 | 68 | 380 | 4,9 | 100 | 529 | | | | 3,5 | 0,7 | 320 | 4300 | 220 |
| | 3,2 | | 355 | 3,2 | | 355 | 3,9 | | 410 | 5,3 | | 565 | | | | 3,9 | 1,5 | 340 | 4600 | 220 |
| | 3,5 | | 380 | 3,5 | | 380 | 4,2 | | 445 | 5,6 | | 600 | | | | 4,2 | 1,0 | 330 | 4700 | 230 |
| 4,2 | | 445 | 4,2 | | 445 | 4,9 | | 520 | 6,3 | | 685 | | | | 4,9 | 1,5 | 340 | 5500 | 230 | |
| SUW 3141 Ln XMW 5004 An XMW 4033 | 0,7 | | 102 | 1,1 | | 130 | 1,8 | | 184 | 3,2 | | 285 | 5,3 | | 430 | 2,8 | 0,7 | 810 | 4000 | 580 |
| | 1,1 | 36 | 130 | 1,4 | 45 | 156 | 2,1 | 68 | 210 | 3,5 | 100 | 310 | 6,0 | 141 | 475 | 3,2 | 1,5 | 790 | 4300 | 580 |
| | 1,4 | | 156 | 2,1 | | 210 | 2,8 | | 260 | 4,9 | | 405 | 6,7 | | 525 | 5,6 | 1,5 | 660 | 5800 | 510 |
| | 1,8 | | 184 | 2,5 | | 235 | 3,2 | | 285 | 5,9 | | 455 | 7,0 | | 550 | 3,9 | 2,0 | 840 | 4300 | 640 |
| SUN 3175 Ln XMW 5009 An XMW 4034 | 2,1 | | 260 | 2,8 | | 330 | 3,9 | | 410 | 4,9 | | 520 | | | | 2,1 | 0,2 | 340 | 3500 | 240 |
| | 2,5 | | 300 | 3,2 | | 355 | 4,2 | | 445 | 5,3 | | 565 | | | | 3,2 | 0,2 | 360 | 4300 | 240 |
| | 2,8 | | 330 | 3,5 | | 380 | 4,6 | | 480 | 5,6 | | 600 | | | | 3,9 | 0,3 | 360 | 4900 | 250 |
| | 3,2 | 64 | 355 | 3,9 | 78 | 410 | 4,9 | 119 | 520 | 6,0 | 175 | 640 | | | | 4,9 | 0,7 | 360 | 5500 | 250 |
| | 3,5 | | 380 | 4,2 | | 445 | 5,3 | | 565 | 6,3 | | 685 | | | | 4,9 | 1,5 | 380 | 5500 | 250 |
| | 4,2 | | 445 | 4,9 | | 520 | 5,6 | | 600 | | | | | | | 5,3 | 1,0 | 380 | 5800 | 250 |
| 4,9 | | 520 | 5,6 | | 600 | 6,3 | | 685 | | | | | | | 5,6 | 1,5 | 380 | 6100 | 250 | |
| SUN 3280 Ln XMW 5005 An XMW 4034 | 2,8 | | 330 | 3,5 | | 380 | 4,6 | | 480 | 5,6 | | 600 | | | | 2,8 | 0,2 | 360 | 4600 | 250 |
| | 3,2 | | 355 | 3,9 | | 410 | 4,9 | | 520 | 6,0 | | 640 | | | | 3,9 | 0,2 | 370 | 4900 | 250 |
| | 3,5 | | 380 | 4,2 | | 445 | 5,3 | | 565 | 6,3 | | 685 | | | | 4,6 | 0,3 | 370 | 5200 | 250 |
| | 3,9 | 102 | 410 | 4,6 | 125 | 480 | 5,6 | 192 | 600 | | 280 | | | | | 5,3 | 0,7 | 380 | 5500 | 270 |
| | 4,2 | | 445 | 4,9 | | 520 | 6,0 | | 640 | | | | | | | 5,6 | 1,0 | 410 | 5500 | 270 |
| | 4,6 | | 480 | 5,3 | | 565 | 6,3 | | 685 | | | | | | | 5,6 | 1,5 | 410 | 5800 | 270 |
| 4,9 | | 520 | 5,6 | | 600 | | | | | | | | | | 6,0 | 1,5 | 410 | 6100 | 270 | |

0,2

0,3

0,7

1,5

3,0

Liquid pressure (bar)

CLASSIC ATOMIZERS

1/2" SIZE

MW

STANDARD BODY



When atomizing higher quantities of liquid is required it is necessary to use larger size atomizer types, as shown in the following pages.

Atomizer design and coding follow the same scheme as smaller size types, with set-up codes and body/option codes.

These atomizer offer the same spray patterns as the smaller models, with a capacity range from 32 to 1.158 liter per hour.





The larger size body has two 1/2" inlets, and it is only available in the standard type with no air actuated spray control possible.

MWB 1520 **B1** **B**

MATERIALS

- B1 = AISI 303 Stainless steel
- B3 = AISI 316 Stainless steel
- D1 = PVC
- T8 = Nickel plated brass

OPTIONS BODY

- A  STANDARD
- B  SHUT-OFF NEEDLE
- C  CLEANING NEEDLE
- D  SHUT-OFF AND CLEAN NEEDLE

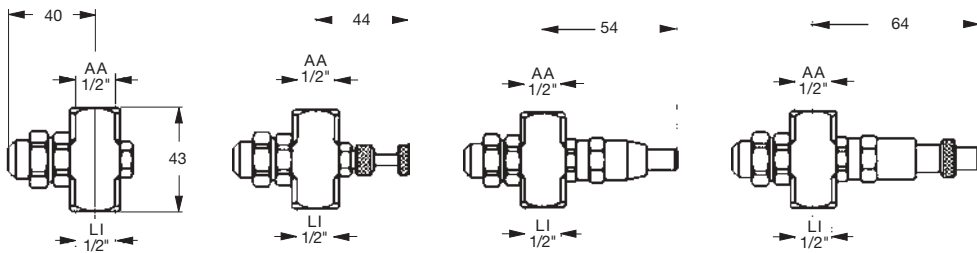

AA = Air inlet 1/2" female

LI = Liquid inlet 1/2" female

1/2" SIZE

PRESSURE PRINCIPLE

INTERNAL MIX

LARGER CAPACITIES

Larger capacities atomizers shown in these pages work on pressure and siphon liquid feed, and internal and external mix principles. A wide angle hollow cone spray is also available. Approximate jet dimensions are given in the table on the right of the page, while advice about operation adjustment is given at page 8. Please note the larger dimensions for the complete atomizer, as given in the previous page.

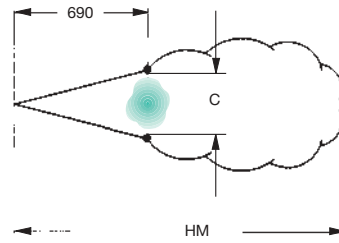

- Materials B1 AISI 303 Stainless steel
- B3 AISI 316 Stainless steel
- D1 PVC
- T8 Nickel plated brass

WH = Water capacity (l/hour)
AM = Air capacity (NI/min)

| Set-up Code | Air pressure (bar) | | | | | | | | | | | | | | | | SPRAY TYPE | | | |
|---|--------------------|------|-----|-----|-----|-----|-----|-----|------|-----|-----|------|-----|-----|------|-----|------------|------|-------|------------------------|
| | 0,35 | | 1,0 | | 2,0 | | 3,0 | | 4,0 | | PA | PL | C | HM | | | | | | |
| SUL 3316 Ln XMW 5201 An XMW 4110 | | | | | | | 2,1 | 213 | 176 | 3,1 | 316 | 214 | 4,2 | 238 | 351 | 2,1 | 2 | 690 | 6700 | WIDE ANGLE ROUND SPRAY |
| | | | | | | | 2,3 | 127 | 249 | 3,2 | 195 | 292 | 4,3 | 154 | 439 | 3,2 | 3 | 690 | 7300 | |
| SUL 3192 Ln XMW 5201 An XMW 4111 | 0,6 | 102 | 184 | 1,1 | 215 | 153 | 2,5 | 185 | 355 | 3,7 | 192 | 560 | 5,0 | 230 | 830 | 0,7 | 0,4 | 650 | 6100 | WIDE ANGLE ROUND SPRAY |
| | 0,7 | 57 | 230 | 1,3 | 124 | 230 | 2,7 | 146 | 410 | 3,9 | 150 | 620 | 5,3 | 158 | 940 | 1,3 | 1,0 | 670 | 7900 | |
| | 0,9 | 32 | 280 | 1,4 | 84 | 280 | 2,8 | 112 | 465 | 4,0 | 119 | 680 | 5,6 | 108 | 1080 | 2,8 | 2,0 | 650 | 6400 | |
| | | | | 3,0 | 86 | 520 | 4,2 | 86 | 770 | | | | | | | 4,0 | 3,0 | 670 | 7300 | |
| | | | | 3,1 | 65 | 580 | 4,6 | 51 | 910 | | | | | | | 5,3 | 4,0 | 690 | 8200 | |
| SUL 3300 Ln XMW 5201 An XMW 4112 | 0,7 | 129 | 325 | 1,7 | 182 | 540 | 3,1 | 265 | 810 | 4,3 | 350 | 1000 | | | | 0,9 | 0,4 | 690 | 7900 | WIDE ANGLE ROUND SPRAY |
| | 0,9 | 82 | 370 | 1,8 | 143 | 590 | 3,2 | 215 | 860 | 4,6 | 260 | 1080 | | | | 1,7 | 1,0 | 660 | 7300 | |
| | 1,0 | 45 | 415 | | | | 3,4 | 173 | 910 | 5,0 | 186 | 1200 | | | | 3,4 | 2,0 | 660 | 7000 | |
| SUL 3740 Ln XMW 5202 An XMW 4113 | 0,7 | 134 | 315 | 1,3 | 320 | 440 | 2,1 | 575 | 570 | 3,0 | 740 | 710 | 3,9 | 840 | 860 | 0,7 | 0,4 | 910 | 3400 | WIDE ANGLE ROUND SPRAY |
| | 0,9 | 100 | 380 | 1,4 | 255 | 520 | 2,2 | 505 | 640 | 3,1 | 690 | 770 | 4,1 | 790 | 930 | 1,4 | 1,0 | 910 | 4900 | |
| | | | | 1,5 | 200 | 590 | 2,4 | 440 | 720 | 3,2 | 630 | 840 | 4,2 | 740 | 990 | 2,5 | 2,0 | 810 | 6100 | |
| | | | | 1,7 | 154 | 670 | 2,5 | 380 | 790 | 3,4 | 570 | 910 | 4,4 | 690 | 1070 | 3,4 | 3,0 | 740 | 6700 | |
| | | | | | | | 2,7 | 330 | 860 | 3,5 | 520 | 980 | 4,5 | 650 | 1140 | 4,5 | 4,0 | 730 | 7600 | |
| | | | | | | | 2,8 | 275 | 930 | 3,7 | 470 | 1050 | 4,6 | 600 | 1210 | | | | | |
| | | | | | | | 3,0 | 235 | 1010 | 3,8 | 420 | 1120 | 4,8 | 550 | 1280 | | | | | |
| | | | | | | | 3,1 | 195 | 1080 | 3,9 | 345 | 1190 | 4,9 | 510 | 1350 | | | | | |
| | | | | | | | | | | 4,1 | 325 | 1260 | 5,1 | 465 | 1430 | | | | | |
| | | | | | | | | | | | | | 5,2 | 425 | 1490 | | | | | |
| | | | | | | | | | | | | | 5,3 | 390 | 1560 | | | | | |
| SUB 2330 Ln XMW 5201 An XMW 4101 | 1,3 | 34 | 350 | 1,7 | 146 | 365 | 3,0 | 230 | 510 | | | | | | | 1,4 | 0,4 | 250 | 6700 | ROUND SPRAY |
| | 1,4 | 25 | 390 | 1,8 | 121 | 395 | 3,1 | 200 | 550 | | | | | | | 2,0 | 1,0 | 250 | 7300 | |
| | 1,5 | 20 | 415 | 2,0 | 102 | 430 | 3,2 | 176 | 590 | | | | | | | 3,2 | 2,0 | 250 | 8200 | |
| | 1,7 | 15,5 | 445 | 2,1 | 86 | 460 | 3,4 | 154 | 620 | | | | | | | | | | | |
| | | | | 2,3 | 72 | 490 | 3,5 | 135 | 660 | | | | | | | | | | | |
| | | | | 2,4 | 60 | 520 | 3,6 | 118 | 700 | | | | | | | | | | | |
| SUB 3740 Ln XMW 5202 An XMW 4102 | 0,7 | 134 | 315 | 1,3 | 320 | 440 | 2,1 | 575 | 570 | 3,0 | 740 | 710 | 3,9 | 840 | 860 | 0,7 | 0,4 | 230 | 7000 | FLAT FAN SPRAY |
| | 0,9 | 100 | 380 | 1,4 | 255 | 520 | 2,2 | 505 | 640 | 3,1 | 690 | 770 | 4,1 | 790 | 930 | 1,4 | 1,0 | 280 | 6400 | |
| | | | | 1,5 | 200 | 590 | 2,4 | 440 | 720 | 3,2 | 630 | 840 | 4,2 | 740 | 990 | 2,5 | 2,0 | 250 | 11300 | |
| | | | | 1,7 | 154 | 670 | 2,5 | 380 | 790 | 3,4 | 570 | 910 | 4,4 | 690 | 1070 | 3,4 | 3,0 | 250 | 12500 | |
| | | | | | | | 2,7 | 330 | 860 | 3,5 | 520 | 980 | 4,5 | 650 | 1140 | 4,5 | 4,0 | 250 | 14300 | |
| | | | | | | | 2,8 | 275 | 930 | 3,7 | 470 | 1050 | 4,6 | 600 | 1210 | | | | | |
| | | | | | | | 3,0 | 235 | 1010 | 3,8 | 420 | 1120 | 4,8 | 550 | 1280 | | | | | |
| | | | | | | | 3,1 | 195 | 1080 | 3,9 | 345 | 1190 | 4,9 | 510 | 1350 | | | | | |
| | | | | | | | | | | 4,1 | 325 | 1260 | 5,1 | 465 | 1430 | | | | | |
| | | | | | | | | | | | | | 5,2 | 425 | 1490 | | | | | |
| | | | | | | | | | | | | | 5,3 | 390 | 1560 | | | | | |
| SUM 3184 Ln XMW 5201 An XMW 4120 | | | | 1,8 | 154 | 590 | 3,4 | 184 | 950 | | | | | | | 2,0 | 1,0 | 910 | 5800 | FLAT FAN SPRAY |
| | | | | 2,0 | 119 | 640 | 3,5 | 157 | 1010 | | | | | | | 3,5 | 2,0 | 970 | 7000 | |
| | | | | 2,1 | 93 | 690 | 3,7 | 133 | 1060 | | | | | | | | | | | |
| SUQ 3740 Ln XMW 5202 An XMW 4121 | 0,7 | 134 | 315 | 1,3 | 320 | 440 | 2,1 | 575 | 570 | 3,0 | 740 | 710 | 3,9 | 840 | 860 | 0,7 | 0,4 | 1190 | 4000 | FLAT FAN SPRAY |
| | 0,9 | 100 | 380 | 1,4 | 255 | 520 | 2,2 | 505 | 640 | 3,1 | 690 | 770 | 4,1 | 790 | 930 | 1,4 | 1,0 | 2110 | 4600 | |
| | | | | 1,5 | 200 | 590 | 2,4 | 440 | 720 | 3,2 | 630 | 840 | 4,2 | 740 | 990 | 2,5 | 2,0 | 2080 | 5200 | |
| | | | | 1,7 | 154 | 670 | 2,5 | 380 | 790 | 3,4 | 570 | 910 | 4,4 | 690 | 1070 | 3,4 | 3,0 | 2160 | 5800 | |
| | | | | | | | 2,7 | 330 | 860 | 3,5 | 520 | 980 | 4,5 | 650 | 1140 | 4,5 | 4,0 | 2260 | 6400 | |
| | | | | | | | 2,8 | 275 | 930 | 3,7 | 470 | 1050 | 4,6 | 600 | 1210 | | | | | |
| | | | | | | | 3,0 | 235 | 1010 | 3,8 | 420 | 1120 | 4,8 | 550 | 1280 | | | | | |
| | | | | | | | 3,1 | 195 | 1080 | 3,9 | 345 | 1190 | 4,9 | 510 | 1350 | | | | | |
| | | | | | | | | | | 4,1 | 325 | 1260 | 5,1 | 465 | 1430 | | | | | |
| | | | | | | | | | | | | | 5,2 | 425 | 1490 | | | | | |
| | | | | | | | | | | | | | 5,3 | 390 | 1560 | | | | | |

0,35

1,0

2,0

3,0

4,0

Liquid pressure (bar)

LARGER CAPACITIES

EXTERNAL MIX/FLAT JET

These set-ups can atomize high viscosity liquids and use the wide regulation range possible with independent regulation of the air and liquid pressure. See previous page for materials.

| Set-up Code | Air pressure (bar) | | | | | | | | | | | | | | | | | | | |
|---|------------------------------|-----|-------------|-----|------------|------|------------|-----|----------|-----|-----|------|-----|------|------|-----|-----|-----|------|----|
| | WH | | AM | | WH | | AM | | WH | | AM | | WH | | AM | | PA | PL | C | HM |
| SUM 4195 Ln XMW 5201 An XMW 4035 | 2,1 | | 877 | 2,8 | | 1075 | 3,2 | | 1174 | 3,9 | | 1358 | 5,6 | | 1839 | 2,5 | 0,2 | 520 | 5800 | |
| | 2,4 | | 962 | 3,2 | | 1174 | 3,5 | | 1273 | 4,2 | | 1457 | 6,0 | | 1952 | 3,5 | 0,4 | 550 | 6700 | |
| | 2,8 | 522 | 1075 | 3,5 | 681 | 1273 | 3,9 | 795 | 1358 | 4,9 | 953 | 1641 | 6,3 | 1158 | 2037 | 3,9 | 0,5 | 580 | 7020 | |
| | 3,2 | | 1174 | 3,9 | | 1358 | 4,2 | | 1457 | 5,3 | | 1754 | 6,6 | | 2122 | 4,9 | 0,7 | 610 | 7630 | |
| | | | | 4,2 | | 1457 | 4,6 | | 1556 | 5,6 | | 1839 | 7,0 | | 2207 | 6,3 | 1,0 | 660 | 8850 | |
| | 0,2 | | 0,35 | | 0,5 | | 0,7 | | 1 | | | | | | | | | | | |
| | Liquid pressure (bar) | | | | | | | | | | | | | | | | | | | |

INTERNAL MIX/HOLLOW CONE JET

This set-up produces a wide angle hollow cone jet, which can be useful in such cases where a coating must be applied inside a pipe or duct. See previous page for materials.

| Set-up Code | Air pressure (bar) | | | | | | | | | | | | | | | |
|---|------------------------------|-------|------------|-----|------------|-----|------------|-----|------------|------|-----|------|------|-----|------|--|
| | WH | | AM | | WH | | AM | | WH | | AM | | WH | | AM | |
| SUZ 3460 Ln XMW 5202 An XMW 4046 | 1,0 | 213,0 | 345 | 1,7 | 394 | 453 | 2,5 | 439 | 634 | 3,4 | 462 | 787 | 5,0 | 484 | 1138 | |
| | 1,1 | 145,0 | 418 | 1,8 | 324 | 526 | 2,7 | 372 | 702 | 3,5 | 416 | 843 | 5,2 | 439 | 1197 | |
| | 1,3 | 97,6 | 575 | 2,0 | 275 | 574 | 2,8 | 322 | 750 | 3,7 | 372 | 891 | 5,3 | 409 | 1254 | |
| | 1,4 | 59,0 | 538 | 2,1 | 207 | 642 | 3,0 | 277 | 818 | 3,8 | 325 | 956 | 5,5 | 366 | 1310 | |
| | | | | 2,3 | 159 | 702 | 3,1 | 272 | 874 | 3,9 | 282 | 1019 | 5,6 | 325 | 1367 | |
| | | | | 2,4 | 116 | 758 | 3,2 | 188 | 931 | 4,1 | 250 | 1084 | 5,8 | 297 | 1429 | |
| | | | | 2,5 | 93 | 829 | 3,4 | 145 | 990 | 4,2 | 209 | 1135 | 5,9 | 257 | 1486 | |
| | | | | 2,7 | 27 | 900 | 3,5 | 114 | 1050 | 4,4 | 168 | 1189 | 6,0 | 232 | 1551 | |
| | | | | | | | | 4,5 | 141 | 1259 | 6,3 | 182 | 1670 | | | |
| | | | | | | | | 4,6 | 77 | 1296 | | | | | | |
| | 0,7 | | 1,4 | | 2,1 | | 2,8 | | 4,2 | | | | | | | |
| | Liquid pressure (bar) | | | | | | | | | | | | | | | |

SIPHON ATOMIZER/FULL CONE JET

This set-up offers the same performances as the set-ups shown at page 15, with a larger capacity. See previous page for materials.

| Set-up Code | Air pressure (bar) | | | | | | | | | | | | | | | | |
|---|--------------------------|------|--------------------------|-------|--------------------------|-----|------------|-----|------------|--|------------|--|------------|--|--|-----|-------|
| | Liquid capacity (Nl/min) | | | | | | | | | | | | | | | | |
| | Liquid pressure (bar) | | Liquid capacity (l/hour) | | | | PA | HM | | | | | | | | | |
| SUC 2230 Ln XMW 5201 An XMW 4045 | 0,7 | 360 | | | | 40 | | | | | | | | | | 1,5 | 6100 |
| | 1,5 | 570 | | | | 97 | 64,0 | | | | | | | | | 2,0 | 6700 |
| | 2,0 | 660 | | | | 117 | 90,0 | | | | | | | | | 3,0 | 7300 |
| | 3,0 | 870 | | | | 150 | 123,0 | 90 | | | | | | | | 3,5 | 7900 |
| | 3,5 | 990 | 300 | 265,0 | 235 | 163 | 133,0 | 104 | | | | | | | | 4,0 | 8800 |
| | 4,0 | 1100 | 305 | 270,0 | 240 | 170 | 143,0 | 115 | | | | | | | | 5,0 | 9800 |
| | 5,0 | 1300 | 315 | 280,0 | 250 | 183 | 157,0 | 129 | 53 | | | | | | | 5,6 | 10700 |
| | 5,6 | 1450 | 320 | 290,0 | 255 | 188 | 164,0 | 136 | 62 | | | | | | | | |
| | 450 | | 300 | | 150 | | 100 | | 200 | | 300 | | 600 | | | | |
| | Gravity head (mm) | | | | Suction head (mm) | | | | | | | | | | | | |

OPTIONS AND ACCESSORIES

SINGLE AIR INLET (Body option U)

Air actuated atomizers can be supplied with a single air inlet for both the atomizing process and the air cylinder, which allows to operate a line of atomizers with only one air line and avoids air waste during the dead cycle times when atomizing is stopped.

With this layout the liquid inside the liquid nozzle will be atomized with a low air/liquid ratio and large drops may be produced: this option may be used for long dead times in atomizing cycles when some large droplet may be tolerated and it is necessary to limit system investment cost.

SPECIAL MATERIALS AND COATINGS

Tungsten carbide air nozzles, air and liquid nozzles with special high technology coatings may be produced to solve problems related to excessive wear from liquids carrying solid particles or build-up of solid deposits or lime inside the atomizer.

Those include Teflon coatings and extra-hard linings.

SPECIAL DESIGNS

Our engineering office is available to design, test and produce bodies, set-ups and complete systems according to the customer requirements.

Special parts, bodies and systems which suit specific customer needs can be arranged under confidentiality agreements, supplied exclusively and not advertised.

ATOMIZER WALL MOUNTING

It is often convenient to mount atomizers through the wall of a tank or a duct for air treatment, keeping the atomizers and the feed lines on the outside for ease of maintenance.

The following parts can serve this purpose for both MW standard atomizers and MX air actuated ones.

Walls thicker than 10 mm

A nipple XMW 0021 xx with an outer tapered thread 3/4" BspT is recommended, with a corresponding passage in the wall threaded 3/4" straight thread.

Walls thinner than 10 mm

For thin walls it is recommended to use a XMW 0020 xx nipple with a 3/4" straight thread, secured through the locknut VAC 0076 xx and the VDA 0075 P7 seal.

The above three parts can be ordered together with the assembly code XMW 0025 xx.

A simple hole with 27 mm diameter is required into the wall.

| | | |
|------------------|------------------------|------------------------------------|
| Materials | Nipple, locknut | B1 AISI 303 stainless steel |
| | | T8 Nickel plated brass |
| | Seal | P7 Oil proof seal material |

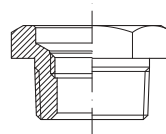

XMW 0021 xx

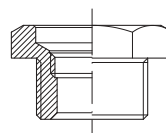

XMW 0020 xx



VDA 0075 P7

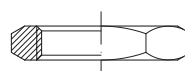

VDA 0076 xx

OPTIONS AND ACCESSORIES

UMR

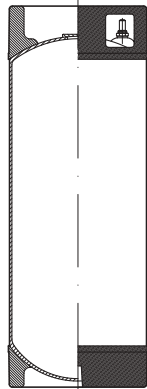
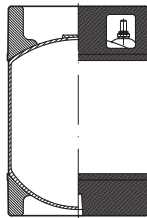

PRESSURE TANKS

These tanks make it possible to produce atomized sprays in places where a liquid supply under pressure is not available.

These tanks, once filled with the required liquid quantity, are put under pressure with the aid of compressed air and are then ready to serve as a source of liquid under pressure.

Completely built out of high quality stainless steel, UMR tanks have the upper and bottom part protected by a rubber lining and are supplied complete of an air tight cover, pressure safety valve and, if required, connection nipples.

The product codes in the following table are given for tanks with cover only, and for tanks with cover and connection nipples.

The maximum operation pressure is given for each type, according to PED norms, from a self-sticking label, see LP value in the table

| | | | |
|-----------|---------|----|--------------------------|
| Materials | Body | B2 | AISI 304 Stainless steel |
| | Coating | E8 | Synthetic rubber |

| Code | Cover and nipples | CA liters | D mm | H mm | W kg | LP bar |
|-------------|-------------------|-----------|------|------|------|--------|
| UMR 0090 B2 | UMR C090 B2 | 9 | 232 | 340 | 3,7 | 4,0 |
| UMR 0190 B2 | UMR C190 B2 | 19 | 219 | 630 | 4,3 | 2,5 |



When a source of liquid under pressure is available, as in the case of a UMR tank, several applications become possible as for example the atomizing cart shown in the picture beside. These carts are designed on specific requirements and are usually fitted with regulation valves to obtain the desired spray characteristics and electronic control. Often used to disinfect single rooms in hospitals, the cart can be programmed to spray for a given time, and to start spraying with a delay which allows the personnel to leave the room before spraying starts.

CE Marking

UMR pressure tanks respect the requirements of the european PED norms

The components in the following list can be ordered as single spare parts by means of their product code.

| | |
|-------------|--------------------------|
| XUM 0052 B2 | Cover complete |
| XUM L090 B2 | Liquid connection nipple |
| XUM A090 B2 | Air connection nipple |

Please note that both connection nipples, air and liquid, can only be supplied as a complete assembly, it is not possible to supply single parts.

AMBIENT HUMIDIFICATION

Keeping a correct value for ambient humidity it is sometimes a necessary pre-requisite in several industrial processes. An ambient humidification system can perform additional functions like keeping ambient temperature within certain limits, keeping flying dust under control, disinfect the room atmosphere or even keep a fire under control while the fire fighting squad reaches the place.

We supply the components shown in the following or can quote a complete system.

A perfect system is obviously based on high quality atomizers and instrumentation, manufactured and guaranteed by qualified and experienced professionals.

We present in the following our MA ultrasonic atomizers and MX air actuated atomizers, which have been designed for optimum performance and applied successfully in tens of thousands to the most different industrial processes.

These long proven devices are complemented by our long time proven regulation and programming cabinets, continuously reconsidered and upgraded to the latest technologies.

Both atomizers shown in this page can be supplied with the following accessories:

- Wall support with swivel joint.
- Quick couplings for air and water

AIR ACTUATED ATOMIZERS

An air actuated MX atomizer is a highly efficient component in a humidification system. It can be delivered as a standard with two air inlets, for liquid atomizing and cylinder control, or with a single air inlet to perform both tasks.

The latter type allows for simultaneous control of several atomizers assembled in line with only one air line, and requires a minimum air pressure value of 2 bars.

Our unique needle design assures perfect tightness when atomizers are shut off.

The swivel mount allows for the best jet orientation to obtain fast and uniform evaporation, while optional coatings are available for the inner nozzles to prevent lime build-up and reduce maintenance cost.



RECOMMENDED MODELS

| | | |
|---------------------|------------------|---------------|
| Stainless steel | two air inlets | MXB 2142 B1B |
| | single air inlet | MXB 2142 B1BU |
| Nickel coated brass | two air inlets | MXB 2142 T8B |
| | single air inlet | MXB 2142 T8BU |

ULTRASONIC ATOMIZERS

The ultrasonic atomizers MA are recommended for humidification systems designed for large surfaces because of their long spray throw and their large liquid capacity.

Operating these atomizers originates a low frequency sound which limits their applications to those systems where personnel is not present at the time when the humidification process starts.

Electric control

The special atomizer body (PVC) contains an electro-valve controlling the liquid supply.

Because of the short liquid path from the valve to the orifice, no dripping occurs.

Each atomizer requires an electrical connection (options 220V, 48V, 24V).

Air control

The atomizer body in stainless steel contains a pneumatic valve controlling the liquid supply.

Liquid feed is automatically stopped when air pressure value falls under 2,5 bar.

This is a very simple system, and easy to be assembled since no electrical connection is required.

However the pneumatic valve can only handle pure water, no additives are allowed.



RECOMMENDED MODELS

MAD 1131 B1
MAD 0802 B1

AMBIENT HUMIDIFICATION

REGULATION CABINET



Maximum system capacity

| Code | LI | AA | AC | Maximum system capacity | |
|-------------|------|------|------|-------------------------|----------|
| | | | | MXB 2142 | MAD 1131 |
| UMQ AA01 V0 | 1/4" | 3/8" | 1/4" | 20 | 6 |
| UMQ AA02 V0 | 3/8" | 1/2" | 1/4" | 40 | 12 |
| UMQ AB01 V0 | 1/4" | 3/8" | * | 20 | 6 |
| UMQ AB02 V0 | 3/8" | 1/2" | * | 40 | 12 |

LI = Water inlet

AA = Atomizing air inlet

AC = Cylinder air inlet

* These cabinets are for single air line atomizers

A regulation cabinet serves the purpose of adjusting the pressure values for air and water in order to obtain the quantity of water evaporated per time unit and the droplet size which best fit the system requirements.

Our cabinets are delivered pre-assembled and tested, complete with all the necessary parts to control the air and water lines, ready to be mounted into the system.

The following devices are included i:

- Ball valves for air and water
- Inlet water filter, 100 micron
- Fine water filter, 5 micron
- Air filter, 100 micron
- Air and water lines electro-valves
- Pressure regulators on air and water lines, each one fitted with control manometer.
- Ball valves for filter purge, on water and air lines.

Cabinet body is in steel sheet, epoxy painted, IP55 electric protection grade

The following table shows the cabinet codes with connection sizes and number of atomizers allowed.

Further info on our Data Sheet 9197.

CONTROL CABINET

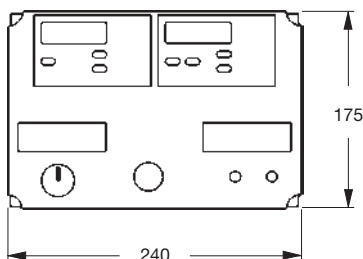

This very modern control cabinet, at the latest technology level, offers all the advantages of microprocessor control.

When assembled before the regulation cabinet it allows to handle the atomizing process in a completely automatic way, with the right timing for each single application being easily programmed.

- Manual (On/Off) or automatic operation.
- Automatically performing atomizing cycles, with pre-fixed idle times.
- Desired humidity and temperature values are kept automatically.
- Digital display indication of present humidity and temperature values.
- Automatic stop when temperature descends below programmed value.
- Humidity and temperature sensors are included in supply.
- Electrical supply 220 V, 50 Hz.

Product code **UMQ B001 V0**

Detailed information on PNR Data Sheet 9198.

GENERAL INFORMATION

Abbreviations list

| | | | | | | | | |
|-----------|---------------------|----------|-----------|--------------------------|--------|-----------|--------------------|--------|
| AM | Air capacity | Nl/min | CA | Internal volume | liters | Ln | Liquid nozzle code | - |
| AH | Air capacity | Ncm/hour | CH | Wrench size | mm | PA | Air pressure | bar |
| AA | Atomizing air inlet | inch | HM | Maximum spray throw | mm | PL | Liquid pressure | bar |
| AC | Cylinder air inlet | inch | HR | Length of coherent spray | mm | WH | Water capacity | l/hour |
| An | Air nozzle code | - | LI | Liquid inlet size | inch | WM | Water capacity | l/min |
| C | Spray width | mm | LP | Max operation pressure | bar | | | |

PRODUCT WARRANTY

PNR products shall be replaced or repaired, as deemed convenient by the Company, if found defective in manufacturing, marking or packing. Above warranty conditions shall apply if notice of defect is received from PNR within 30 days from date of product installation, or within one year from date of shipment.

The cost of above said replacement or repair as above specified shall be the exclusive remedy for any breach of any warranty and PNR shall not be held liable for any damage due to personal injuries or commercial losses coming from product malfunction.

PNR desires to handle warranty returns avoiding mistakes and giving Customers the best possible service.

Therefore we have organized a Company procedure with the following steps to be followed :

- 1 Contact PNR Quality Manager to obtain a RIN (return identification number) and a 3DA A04 Form.
- 2 Fill the Form 3DA A04 as required, including RIN number and include into material shipment
- 3 PNR shall repair or replace the product as appropriate, and return it together with a copy of our internal inspection Report.

PNR wishes to obtain complete Customer satisfaction, and all our personnel has been instructed in order to make available, in such an event, a perfect product in the shortest possible time.

OTHER PRODUCT RETURNS

Receiving returned products not precisely identified can originate delays in handling the single cases and even some product losses. In order to avoid such problems please follow the PNR procedures as described below.

PRODUCT DELIVERED ERRONEOUSLY BY PNR

- 1 Obtain from PNR a RIN (Return ident number) and a 3DA A04 Form.
- 2 Return products to PNR including the 3DA A04 Form properly filled including RIN number.
- 3 PNR shall issue a Credit Note payable to you including product and all transport cost.

PRODOTTI ORDERED ERRONEOUSLY TO PNR

- 1 Returned products will only be accepted if in new original condition and properly packed.
- 2 Obtain from PNR a RIN (Return ident number) and a 3DA A04 Form.
- 3 Return products to PNR including the 3DA A04 Form properly filled including RIN number.
- 4 A 10% inspection and re-stocking charge and all transport cost are at charge of Customer.
- 5 A Credit note for the proper amount shall be issued and paid.

SPECIAL NON CATALOG PRODUCTS

The return of these products is only possible after PNR has issued an offer for purchase.

DISCLAIMER

Our products are manufactured with the best care and according to the latest developments of the technology, but we cannot assure that every one of our products is perfectly fit for any possible specific process.

The information provided in this Catalog is provided "as it is" and we make no warranty of any kind with respect to the subject matter or accuracy of the information contained herein. This publication may include technical inaccuracies or typographical errors and changes may be periodically made to the information herein without previous notice.

SENDING LIST

In order to automatically receive updates of our technical Documentation please photocopy this card and send it to us inside a sealed envelope, your details shall be kept on our Permanent Mailing List.

CTG AZ 18 BR

| | | | | | | |
|----|----------|--------|--|--|--------------------------|--|
| 01 | COMPANY | | PNR PRODUCT RANGE | | PAPERMILL PRODUCTS | |
| 02 | NAME | | GENERAL PURPOSE SPRAY NOZZLES | | STEELWORK NOZZLES | |
| 03 | FUNCTION | | AIR ASSISTED ATOMIZERS | | SPRAYDRY NOZZLES | |
| 04 | ADRESS | | COMPLEMENTARY PRODUCTS AND ASSEMBLY FITTINGS | | FIRE FIGHTING COMPONENTS | |
| 05 | PHONE | FAX | TANK WASHING SYSTEMS | | | |
| 06 | WEB SITE | E-MAIL | EVAPORATIVE COOLING SYSTEMS | | | |

PNR UK LTD

16, Sugarbrook Rd - Aston Fields Industrial Estate
BROMSGROVE WORCS B60 3DW
Tel (01527) 579 066 - Fax (01527) 579 067
www.pnr.co.uk - E-mail spraynozzles@pnr.co.uk
www.pnr-nozzles.com

CTG AZ18 BR



Our products are distributed by the following PNR Companies:

PNR America
PNR Asia
PNR Baltic

PNR Benelux
PNR Czech Republic
PNR Deutschland
PNR France

PNR Italia
PNR Mexico
PNR U. Kingdom

We are represented in the following Countries

Argentina
Australia
Austria
Brazil
Canada
Chile
China
Czech Republic
Denmark
Finland
Greece

Korea
India
Indonesia
Iran
Ireland
Island
Malaysia
New Zealand
Norway
Pakistan
Poland

Portugal
Russia
Singapore
Slovenia
Spain
South Africa
Sweden
Taiwan
Turkey
Ukraine
Venezuela

